

RADIO'S LIVEST MAGAZINE



August  
25 Cents  
Canada 30¢

39

# Radio-Craft

HUGO GERNSBACK Editor



AN IMPROVED  
"TREASURE" LOCATOR

See Page 76

J. PIGNONE

Syntronic Organ—The P. E. Cell—Music Guides Airplanes—5 Tube Portable  
Converting Old Receivers—P. A. Systems Aid Surgery—A Long-Wave Tuner

# ANNOUNCING

## A GOLDEN OPPORTUNITY FOR ALERT RADIO MEN IN THE NEXT GREAT INDUSTRY



PRE-PUBLICATION OFFER

\$4.00

THE idea of electricians, radio service men and other mechanically inclined men, servicing Air Conditioning and Refrigeration Units is self-evident and the thought has occurred to some untold thousands ever since air conditioning equipment has been installed in public auditoriums, theatres, studios, department stores, office buildings and manufacturing plants. The tremendously broad possibilities in this new industry are bound to give employment and success to men far-sighted enough to see its advancement and development. We quote an excerpt from Mr. Hugo Gernsback's editorial which appeared in the September, 1933 issue of *Everyday Science and Mechanics*:

*"I advise young and progressive men to go into the air-conditioning business during the next few years; because, this, without a doubt, is the coming industry in this country. Thousands of small firms will spring up, undertaking to air-condition private houses, small business offices, factories, etc. We are not going to tear down every building in the United States immediately. It will be a gradual growth; yet small installation firms will air-condition small houses, and even single offices in small buildings."*

This is only partial proof of the certain success of this new field. Further assurance is that engineering schools have already added many important courses on air conditioning to their regular curriculum. Architects and building contractors are giving considerable thought to installation of this equipment in structures which are now being planned and built. The beginning of this business will probably be similar to the auto and radio industry, but in a few short years it will surpass these two great fields.

## Official Air Conditioning Service Manual

352 Pages  
Over 600 Illustrations  
9" x 12" in Size  
Flexible, Loose Leaf  
Leatherette Cover



The OFFICIAL AIR CONDITIONING SERVICE MANUAL is being edited by L. K. Wright, who is an expert and a leading authority on air conditioning and refrigeration. He is a member of the American Society of Refrigerating Engineers, American Society of Mechanical Engineers, National Association of Practical Refrigerating Engineers; also author of the OFFICIAL REFRIGERATION SERVICE MANUAL and other volumes.

In this Air Conditioning Service Manual nearly every page will be illustrated; every modern installation and individual part carefully explained; diagrams furnished of all known equipment; special care given to the servicing and installation end. The tools needed will be illustrated and explained; there will be plenty of charts and page after page of service data.

Remember there is a big opportunity in this new field and plenty of money to be made in the servicing end. There are thousands of firms selling installations and parts every day and this equipment must be cared for frequently. Eventually air conditioning systems will be as common as radios and refrigerators in homes, offices and industrial plants. Why not start now—increase your earnings with a full- or spare-time service business.

You have the opportunity to get your copy of the OFFICIAL AIR CONDITIONING SERVICE MANUAL today—at a saving of ONE DOLLAR. When the book comes off press, which will be August 10th, the price will be \$5.00 a copy. YOUR ORDER TODAY BRINGS YOU A COPY FOR \$4.00. POSTAGE PREPAID. This is our usual courtesy, pre-publication offer which enables us to determine the approximate print order for the first press run. Send us the coupon today, together with a deposit of \$2.00. When the book reaches you, you pay the other \$2.00.

Here are some of the chapter heads of the AIR CONDITIONING SERVICE MANUAL:

### Contents in Brief

History of Air Conditioning; Fundamental Laws; Methods of Refrigeration; Ejector System of Refrigeration; Compression System of Refrigeration; Refrigerants; Lubricating Oils; Liquid Throttle Devices; Servicing Expansion and Float Valves; Servicing Refrigerating Systems; Control Devices; Thermodynamics of Air Conditioning; Weather in the United States; The Field of Air Conditioning; Insulating Materials; Heat Transmission Through Walls; Complete Air Conditioning Systems; Estimating Requirements for the Home, Small Store, Restaurant; Layout of Duct Systems; Starting Up a System; Operating and Servicing Air Conditioning Systems; Air Filtration, Ventilating and Noise Eliminating Devices; Portable Electric Humidifiers and Room Coolers; Automatic Humidifiers; Air Conditioning Units for Radiator Systems and Warm Air Systems; Central Conditioning Units, etc.

### MAIL COUPON TODAY!

GERNSBACK PUBLICATIONS Dept. RC-834  
99 Hudson Street, New York, N. Y.

Gentlemen: Enclosed you will find my remittance of Two Dollars for which you are to send me One Copy of the OFFICIAL AIR CONDITIONING SERVICE MANUAL, postage prepaid, as soon as it comes off the press. I am to pay the additional Two Dollars to postman when it is delivered. It is understood that the regular price of the book will be FIVE DOLLARS when it comes off the press, and I am now paying only a pre-publication price of Four Dollars.

Name \_\_\_\_\_

Address \_\_\_\_\_

City \_\_\_\_\_ State \_\_\_\_\_

(Send remittance in form of check, money order or unused U.S. Postage Stamps. Register letter if it contains stamps or currency.)

GERNSBACK PUBLICATIONS, INC.  
99 Hudson Street New York, N. Y.

# OPPORTUNITIES

*are many*

## for the Radio Trained Man



Don't spend your life slaving away in some dull, hopeless job! Don't be satisfied to work for a mere \$20 or \$30 a week. Let me show you how to get your start in Radio — the fastest-growing, biggest money-making game on earth.

### Jobs Leading to Salaries of \$50 a Week and Up

Prepare for jobs as Designer, Inspector and Tester—as Radio Salesman and in Service and Installation Work—as Operator or Manager of a Broadcasting Station—as Wireless Operator on a Ship or Airplane, or in Talking Picture or Sound Work—HUNDREDS OF OPPORTUNITIES for a real future in Radio!

## Ten Weeks of Shop Training

### Pay Your Tuition After Graduation

We don't teach by book study. We train you on a great outlay of Radio, Television and Sound equipment—on scores of modern Radio Receivers, huge Broadcasting equipment, the very latest and newest Television apparatus, Talking Picture and Sound Reproduction equipment, Code Practice equipment, etc. You don't need advanced education or previous experience. We give you — RIGHT HERE IN THE COYNE SHOPS — the actual practice and experience you'll need for your start in this great field. And because we cut out all useless theory and only give that which is necessary you get a practical training in 10 weeks.

# TELEVISION *and* TALKING PICTURES

And Television is already here! Soon there'll be a demand for THOUSANDS of TELEVISION EXPERTS! The man who learns Television now can have a great future in this great new field. Get in on the ground-floor of this amazing new Radio development! Come to COYNE and learn Television on the very latest, newest Television equipment. Talking Picture and Public Address Systems offer opportunities to the Trained Radio Man. Here is a great new Radio field just beginning to grow! Prepare NOW for these wonderful opportunities! Learn Radio Sound Work at COYNE on actual Talking Picture and Sound Reproduction equipment.

## PAY FOR YOUR TRAINING After You Graduate

I am making an offer that no other school has dared to do. I'll take you here in my shops and give you this training and you pay your tuition after you have graduated. Two months after you complete my course you make your first payment, and then you have ten months to complete your payments. There are no strings to this offer. I know a lot of honest fellows haven't got a lot of money these days, but still want to prepare themselves for a real job so they won't have to worry about hard times or lay offs.

I've got enough confidence in these fellows and in my training to give them the training they need and pay me back after they have their training.

If you who read this advertisement are really interested in your future here is the chance of a life time. Mail the coupon today and I'll give you all the facts.

## ALL PRACTICAL WORK At COYNE in Chicago

ALL ACTUAL, PRACTICAL WORK. You build radio sets, install and service them. You actually operate great Broadcasting equipment. You construct Television Receiving Sets and actually transmit your own Television programs over our mod-

ern Television equipment. You work on real Talking Picture machines and Sound equipment. You learn Wireless Operating on actual Code Practice apparatus. We don't waste time on useless theory. We give you the practical training you'll need—in 10 short, pleasant weeks.

## MANY EARN WHILE LEARNING

You get Free Employment Service for Life. And don't let lack of money stop you. Many of our students make all or a good part of their living expenses while going to school and if you should need this help just write to me. Coyne is 33 years old. Coyne Training is tested—proven beyond all doubt. You can find out everything absolutely free. Just mail coupon for my big free book!

H. C. Lewis, Pres. RADIO DIVISION Founded 1899  
**COYNE ELECTRICAL SCHOOL**

500 S. Paulina St., Dept. C4-8H Chicago, Ill.

Mail Coupon Today for All the Facts

H. C. LEWIS, President  
Radio Division, Coyne Electrical School  
500 S. Paulina St., Dept. C4-8H Chicago, Ill.

Dear Mr. Lewis:—Send me your Big Free Radio Book, and all details of your Special Offer, including your "Pay After Graduate" offer.

Name .....

Address .....

City..... State.....



HUGO GERNSBACK, Editor-in-Chief

J. T. BERNSELY, Managing Editor

C. W. PALMER  
Associate Editor

R. D. WASHBURNE  
Technical Editor



## IN OUR NEXT FEW ISSUES:

**HOW SHIELDED LEAD-INS MISBEHAVE.** Should the antenna down-lead be shielded? Should the ground-lead be shielded, and why? When, and in what manner it is most desirable to shield the input leads to the radio set, is the subject of an interesting article by a practical radio man who has carried out numerous experiments tending to prove which arrangements of the antenna system are preferable.

**A GRID-DIP OSCILLATOR FOR THE LABORATORY.** At the words "grid-dip oscillator" some radio men may be inclined to say "Pooh" only an oscillator with a milliammeter in the grid circuit." However, the author goes several steps beyond the aforementioned premise and offers a perfected instrument, the design of which will thrill the technical heart of every radio man who aspires to a high grade, yet inexpensive, laboratory.

**ALL-WAVE RADIO RECEPTION.** This is the title of a new department that will be inaugurated in RADIO-CRAFT for the benefit of those who wish to enjoy their "standard" (200 to 550 meter) radio receiver to the maximum. Useful data are furnished so that those who are sufficiently fortunate to reside in a location that is good for DX reception may be enabled to hear some of the remote trans-oceanic programs in this band.

For the short-wave enthusiast, equivalent information is furnished, including the operating hours, types of programs, and identifying signals of all the foremost stations throughout the world.

For those who own "all-wave" receivers of the type that is truly so, that is, capable of receiving programs in the wavelength range of 550 to 2,000 meters, there is furnished interesting information gleaned from radio stations, correspondents and magazines from all points on the globe.

## CONTENTS OF THE AUGUST, 1934, ISSUE

VOLUME VI

Number 2

Editorial: Radio Trends.....	Hugo Gernsback	69
The Radio Month in Review.....		70
Radio Pictorial.....		72
The Latest Radio Equipment.....		74
An Improved "Treasure" Locator.....	C. W. Palmer	76
A "Syntronic" Organ.....	Edward E. Kassel	77
Surgical-Room Sound Installations.....	J. T. Bernsley	78
A Well-Designed 5 Tube Portable.....	R. M. Dean	79
Broadcasts Guide Airplanes.....	Henry W. Roberts	80
International Radio Review.....		82
Important Facts About the New All-Wave Antenna Systems, Part II.....	R. D. Washburne	84
The P.E. Cell.....	A. J. McMaster	86
A Long-Wave Tuner.....	F. R. Harris	87
Uplifting the Servicing Profession, Part III.....	F. E. Colt	88
Converting Old Receivers.....		89
A Self-Powered 2 Tube Short-Wave Converter.....	Ellis Cohen	90
A Versatile Oscillator.....	S. S. Egert and S. Bagno	90
An Improved Magnetic Speaker.....		91
A Complete Set Tester.....	W. H. Ashcroft	91
A Mobile P.A. System.....	W. F. Marsh	92
A Deluxe 4 Tube Short-Wave Converter.....	S. Miller	92
Operating Notes.....		93
Short Cuts in Radio.....		94
RADIO-CRAFT'S Information Bureau.....		96
Readers' Department.....		98
RADIO SERVICE DATA SHEETS:		
No. 119—Grunow Remote Control Model 1101 11 Tube Superheterodyne.....		97
No. 120—Bosch Model 360 All-Wave (15 to 550 Meters) 7 Tube Superheterodyne.....		100
Book Review.....		109

RADIO-CRAFT is published monthly, on the fifth of the month preceding that of date; its subscription price is \$2.50 per year. (In Canada and foreign countries, \$3.00 a year to cover additional postage.) Entered at the post office at Mt. Morris, Ill., as second-class matter under the act of March 3, 1879.

Text and illustrations of this magazine are copyright and must not be reproduced without permission of the copyright owners. We are also agents for WONDER STORIES and EVERYDAY SCIENCE AND MECHANICS. Subscription to these magazines may be taken in combination with RADIO-CRAFT at reduced Club rates. Write for information.

Copyright 1934. Continental Publications, Inc.

HUGO GERNSBACK, President

I. S. MANHEIMER, Secretary

Published by Continental Publications, Inc. Publication office: 404 N. Wesley Ave., Mount Morris, Illinois. Editorial and Advertising Office: 99 Hudson Street, New York City. Chicago Advertising Office: L. F. McClure, 919 North Michigan Avenue, Chicago, Ill. Western Advertising Office: Loyd B. Chappell, 511 So. Alexandria St., Los Angeles, Calif.

London Agent: Hachette & Cie., 3 La Belle Sauvage, Ludgate Hill, E.C. 4  
Paris Agent: Hachette & Cie., 111 Rue Reaumur  
Australian Agent: McGills Agency, 179 Elizabeth St., Melbourne

# Service Men's Essentials for All Members of the

# ORSMA



No. 14—50c each  
(Plus 10c for Postage)

No. 3—60c per pad of 50  
\$3.00 per ten pads, each of 50



No. 5—50c each

Mail This Coupon Today!

**Application for ORSMA Membership in**

Executive Secretary, ORSMA  
99 Hudson Street, New York, N. Y.

Kindly send an application blank for  
 Full Membership  
 Associate Membership

Name .....

Street or Box .....

City ..... State .....

RC-831

## SERVICE MEN'S ESSENTIALS

THE OFFICIAL RADIO SERVICE MEN'S ASSOCIATION has made arrangements to supply a number of "Service Men's essentials" for the use of its members and associate members. Only members and associate members can buy these items; they are not sold to others.

These essentials are priced at cost, plus a small additional fee which is the only source of income that the Association has. No one obtains any profit or benefit, except the Association itself. Whatever profit accrues, is reinvested for the furtherance and enlargement of the Association.

By using the letterheads, billheads, etc., you present the business-like appearance to your customers, so essential to successful servicing. In addition, the Association has made arrangements with most of the prominent manufacturers to allow special discounts to members, providing ORSMA letterheads are used when ordering.

### No. 1 ORSMA LETTERHEADS

These letterheads, shown on the right, are furnished with your name, address and telephone number, printed on excellent paper. They are sold in lots of 100 or multiples thereof, with a distinct saving for single orders of 1,000 or more. You would have to pay many times more if you ordered small lots from your local printer. Per 100, 60c; per 1000, \$3.00.

### No. 2 ORSMA ENVELOPES

These are furnished to match the letterheads, printed with your name and address and seal of the Association. They go hand-in-hand with the letterheads and are usually ordered in the same quantity. Per 100, 60c; per 1000, \$3.00.

### No. 3 ORSMA SERVICE RECORD CARDS

They serve a double purpose; whenever you complete a job you fill out the report-form and hand it to the customer; this is the "psychological moment" to collect. By the use of carbon paper a permanent record is kept which is a valuable asset to your business. They are furnished with your name, address and telephone number. Per pad of 50, 60c; per 10 pads, each of 50, \$3.00.

### No. 4 ORSMA INSPECTION LABELS

The label is to be filled in with the proper dates, and pasted inside the set or cabinet where the customer will see it. It is a continuous reminder to him that, when service is needed, he can call you again. The advantage is apparent. Per 100, 50c; per 1000, \$3.00.

### No. 5 ORSMA LABEL BUTTON

At the suggestion of many members a handsome label button bearing the name and emblem of the Association has been designed. It signifies to your fellow members that you belong to the same Association;—and in addition it gives your customers a better appreciation of the professional nature of your work. 50c each.

### No. 6 ORSMA BUSINESS CARDS

These are furnished on a fine grade of paper in two colors with a hlotter back. Thus they present an added incentive to your customers to keep them in a prominent place, where they will do the most good. They are printed with your name, address and telephone and bear the official seal of the Association. Per 100, 75c; per 1000, \$4.00.

### No. 9 & 10 ORSMA EMBLEM CUTS

These cuts for printing, advertising, etc., are furnished in two styles and sizes. They may be used for newspaper or telephone-book advertisements or for printing of any kind. Large size, 1 1/4 x 1 1/4 in., \$1.35 each; small size, 3/4 x 3/4 in., \$1.20 each.

### No. 11 ORSMA MEMBERSHIP SIGN

A set of three of these signs, printed on heavy cards, and having holes punched in order to hang in your office or store, and are sold to members and associate members. They are large enough so that they are quite prominent and the two tone effect makes a very attractive appearance. Set of three, 50c.

### No. 12 ORSMA ADVERTISING DISPLAY SIGN

A two color sign printed in large letters with your name, address and telephone, with the seal of the Association. This sign is sold in quantities of 25 or more and is ideal for hanging in stores, offices, etc., for advertising purposes. Set of 25 cards, \$3.00.

### No. 13 RADIO SERVICE MEN'S ASSORTMENT PACKAGE

This includes one gold filled label button, 100 letterheads, 100 envelopes, 50 service record cards, and 100 labels printed with your name and address as described above. The whole assortment costs only—\$3.00—a worth-while saving. Complete, \$3.00.

### No. 14 ORSMA MEMBER CERTIFICATE

A handsome diploma-like certificate engraved on stiff vellum-bound. The certificate is personally signed by the President and Executive Secretary and the corporation stamp of the Association is impressed on a red seal attached to it. Your name, certificate number and date of registration are lettered by hand and the Certificate is mailed in a cardboard tube to insure safe delivery. Each 50c, plus 10c for postage.

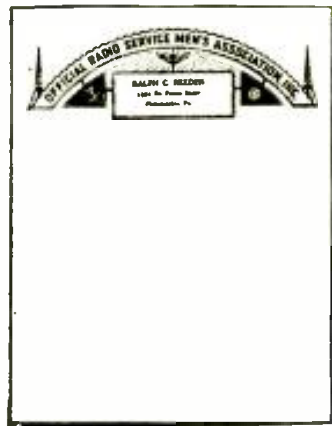

No. 1—60c per 100  
\$3.00 per 1000



No. 2—60c per 100  
\$3.00 per 1000



No. 6—75c per 100  
\$1.00 per 1000



No. 4—60c per 100  
\$3.00 per 1000

OFFICIAL RADIO SERVICE MEN'S ASSOCIATION  
99 Hudson Street, New York, N. Y.

Please send me the following RADIO SERVICE MEN'S ESSENTIALS which I have selected from this advertisement. My remittance for \$..... is enclosed. Send remittance in form of check or money order. Register letter if it contains cash, currency or unused U. S. Postage Stamps.

.....

.....

Name ..... ORSMA No. ....

Address ..... City and State .....

RC-834



# GOOD NEWS!

"If you could only see the vast amount of new material which our editorial staff is compiling for the new manual, you will agree with me when I say that *the 1935 Official Radio Service Manual of 1,000 Pages will be the greatest book I have ever published.*"

*Hugo Gernsback*

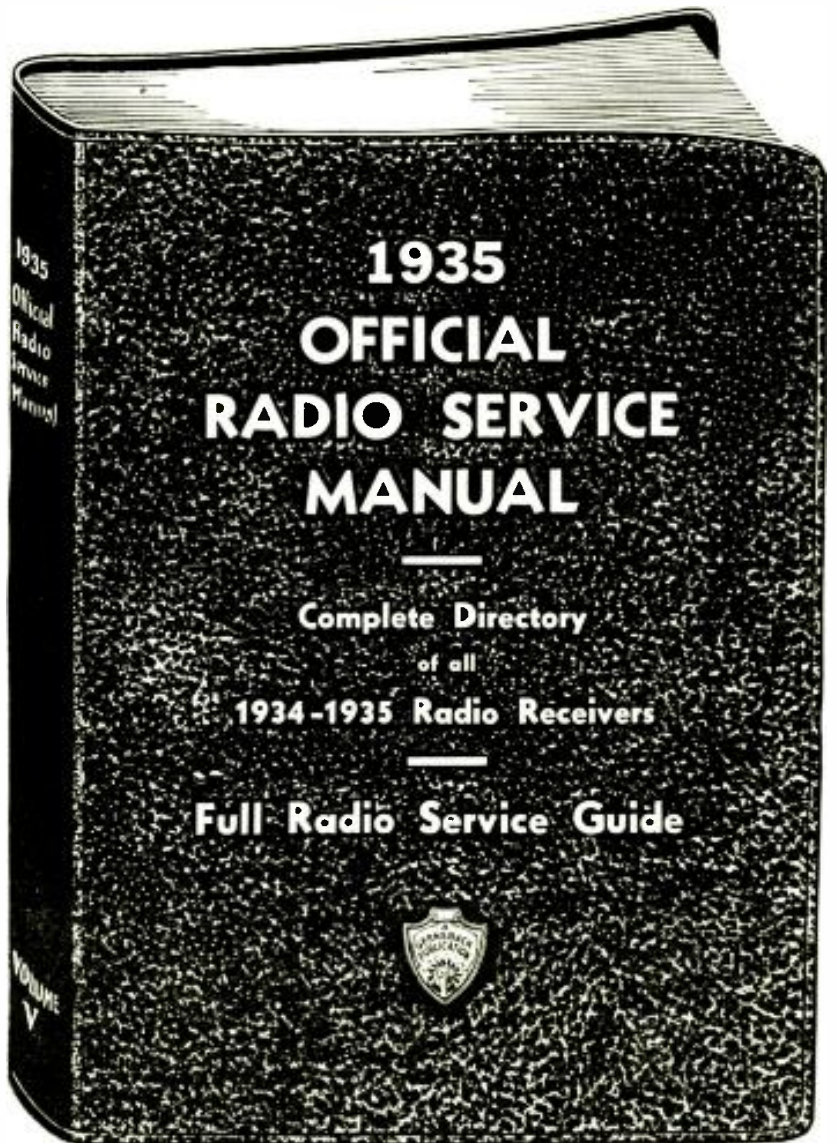

**FREE!** Write for our interesting 8-page booklet, in two colors, which tells the entire story about the NEW 1935 OFFICIAL RADIO SERVICE MANUAL. It's FREE. Simply fill in the coupon below — paste on a one-cent post card, and mail to the publishers.

MAIL COUPON TODAY FOR FULL DETAILS

GERNSBACK PUBLICATIONS, Inc., Dept. A  
99 Hudson St., New York, N. Y.

Gentlemen: Please send me without delay, a copy of the 8-page brochure, in two colors, giving complete details about the NEW 1935 OFFICIAL RADIO SERVICE MANUAL, and special money-saving offer.

Name \_\_\_\_\_

Address \_\_\_\_\_

City \_\_\_\_\_ State \_\_\_\_\_

DON'T FAIL TO SEND FOR THE 8-PAGE BROCHURE WHICH TELLS ABOUT THE NEW MANUAL



"Takes the Resistance Out of Radio"

Editorial Offices: 99 Hudson Street, New York, N. Y.

HUGO GERNSBACK, Editor

Vol. VI., No. 2, Aug., 1934

# RADIO TRENDS

An Editorial by HUGO GERNSBACK

**E**VER since the radio industry came into its own, with the advent of broadcasting, each year has shown a certain trend toward producing even better and more modern radio sets.

If we visualize the trend during the past few years, it will be noted that the radio industry has followed certain unmistakable paths. From the radio console, the way led to the midget sets, which became the furore a few seasons back. Then we had an avalanche of cigar-box models to fit the depression pocketbooks; and last season the all-wave (short-wave and broadcast-wave combination) radio sets made their appearance. The latter are still going strong, and the chances are that, in the next few seasons, unless a radio set is equipped to take care of short-wave requirements, it will be most difficult to sell.

In other words, the radio set is still simply a radio set, whose business it is to bring in 100% aural ("by ear") entertainment. The next great development in radio is the combination radio and television outfit, not, as yet, even on the horizon. And, while some of our large radio interests are spending vast sums in research toward television, it may be some time—several years at least—before a real aural-and-visual radio set is developed that will stand every criticism of a spoiled public.

To be sure, television has long been with us. As a matter of fact, in one form or another, it has been with us since 1884, when Nipkow invented the scanning disc. But the television image which we are getting today seems to the great public used to the perfect vision of the movie screen, still pitifully inadequate. As long as we cannot have an image with excellent details, and at least one foot square, that you can view in bright daylight, it is obvious the television set of the future has not arrived.

For this reason, the trend of radio sets for the next few years undoubtedly will remain along strictly aural lines.

More and more radio engineers are coming to believe in high-fidelity reception. If you have, for instance, a radio set of the vintage of 1928, and a good 1934 set as put out by first-class manufacturers today, and you demonstrate them side by side, the difference is laughable. The tinny, nasal tone of reception in the past is missing in the new set. Our ears are becoming more critical to what they hear. The radio receiver is no longer just a machine to make sounds, but it is well on the road to become a really musical instrument of reproduction. The trouble, even with modern sets, is that the best dynamic reproducers which we have today are still a long ways from giving high-fidelity reproduction. As yet, most loudspeakers are unbalanced, and reproduce certain notes better than others. Some loudspeakers will emphasize the lower register at the expense of the upper, or vice versa. For that reason, some manufacturers continue, and with good reason, to put out sets that have two loudspeakers, to gain higher fidelity.

It has been said by many experts that you cannot have a cigar-box, or even a midget, radio set that will give you good

acoustic quality. The radio music expert will point out to you that only in a large set, where a sufficient volume of air is moved, can you have high fidelity. That requires a larger diaphragm: much larger, in fact, than most of the loudspeakers now have.

A tremendous amount of research in this direction alone must yet be done and the trend during the next few years, unquestionably, will be to get better and better musical quality—so that all notes, from the lowest to the highest, will emerge from the speaker with absolute fidelity.

The radio broadcasters themselves have done a large amount of research to make this result possible; and it may be said that, today, the better stations in the United States do an excellent job in transmission, while receiver design has not, as yet, caught up with the broadcasters. By that I mean that the broadcasters are transmitting on a reasonably good, high-fidelity system; but the receivers do not reproduce the transmitted sounds faithfully.

There has been, by mutual consent of the tube manufacturers, a breathing spell from putting out new tubes. At one time last year we had avalanche upon avalanche of new tubes; to such a degree that even tube experts found it difficult to keep in touch with developments. So a halt was declared and, with few exceptions, the tube manufacturers abstained from placing upon the market new and revolutionary tubes (which probably will be produced during the next season). The radio industry simply could not cope with the output of the new tubes any longer, as it tended to scrap everything that went on before, and the multitude of new tubes also began to bewilder the public. In order to give the radio set manufacturers and the public a breathing spell and time to digest this tremendous number of new tubes, for the first time in the history of radio, a holiday was declared, which probably was unique in the annals of radio itself. In other words, an obvious trend was reversed, as far as the tubes were concerned. Instead of putting out new tubes, old ones are being improved at the present time.

If the tube manufacturers will now take heed, and spend a little time and study to design tube bases that can be handled conveniently instead of the present insanity, they would, no doubt, secure a lot of good will from the public and Service Men alike. When you take a modern six- or seven-prong tube, and try to insert it in the socket, it is a most time-consuming, nerve-racking experience. The poor Service Man who has to replace tubes all day long is totally out of patience with the stupid tube-base engineering, if it really deserves the name of engineering. It may be a small detail, but it is an important one. You could not imagine any manufacturer in the electrical industry, for instance, getting out a connecting plug with which you would have to fiddle around for minutes at a time, in order to insert it in its proper place.

Let the tube industry, instead of putting out new tubes next season, re-design its bases, and earn the everlasting gratitude of every one who ever uses a radio tube.

# THE RADIO MONTH

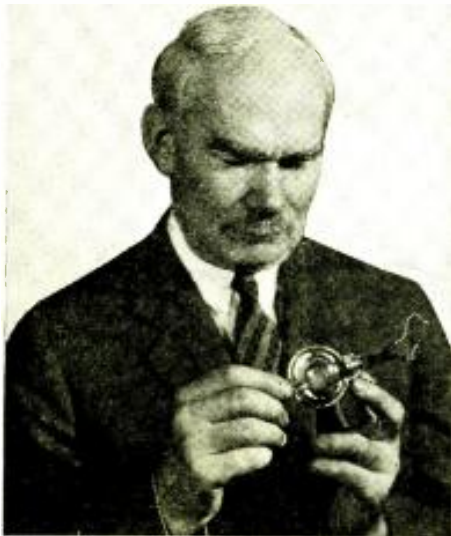

Lee DeForest, finally awarded regeneration patent by Supreme Court, and his first audion tube.

## DeFOREST WINS "FEEDBACK" CASE AGAIN

What will probably be the last decision in a long series of see-saw litigation over the "feedback" or regeneration patent, an opinion last month by Justice Cardozo in the Supreme Court gave final honors to Lee DeForest. Thus, the decree handed down by the Second Circuit Court of Appeals that Edwin H. Armstrong was the inventor was upset, while the opposite originally decided by the Eastern District Court of New York was upheld.

DeForest, inventor of the audion (three-element tube) and shown in the accompanying photograph, and Major Armstrong have been each credited with having discovered regeneration, by various court decisions which began back in 1922. One of DeForest's original sketches is reproduced on these pages and was one of the most important factors in affecting the decision.

Regeneration in radio receivers is of great importance since this method of feeding back energy from the plate circuit of a tube to the grid results in tremendous amplification and without which principle many receivers would be insensitive. It was also responsible for the increase of interest in radio

reception in the old days, inasmuch as many one to three tube receivers in the hands of experimenters at that time did much towards winning over skeptics.

Of unusual interest is the fact that at the Institute of Radio Engineers' convention held in Philadelphia last month, the board of directors of this organization refused to take back a gold medal tendered by Major Armstrong, who had previously been awarded it for his contribution to the radio science. Their explanation was that the recent decision giving originality for regeneration to DeForest would have no effect on their award since the Major had made many other valuable inventions which entitled him to the gold medal. RCA is not affected by this decision since they were licensed by A. T. & T. who acquired the rights from DeForest.

## BROOKLYN RADIO SNARL TRACED TO ILLICIT AMATEUR

FEDERAL officials madly tore about New York City last month, in an effort to unscramble departmental broadcasts and police radio calls from an interfering station which cluttered up these short wavelengths. The interfering station was finally located in Brooklyn, and was constructed and operated by Philip Room, 21 years of age.

When the radio inspectors located the transmitter, and burst in upon Room, he was sending messages "to no one in particular." However, officials are inclined to believe that the eccentric messages were apparently coded and that they were intended for one or more be-

lated rum runners. Room, on the other hand, explained that he was a musician and that he had no idea he was doing anything illegal. He claimed his broadcasts were impromptu and had no significance. Federal Commissioner Martin C. Epstein ordered him held in \$500 bail for violation of the Federal Radio Act of 1929.

The unlicensed station was composed of a small, inexpensive transmitter, and of the type that was relatively easy to construct. It employed three microphones, and the radio inspectors claimed it had a range of about 500 miles. They are attempting to decode the messages.

## GOLD TELEGRAPH KEY FORMALLY OPENS WLW

WHEN President Roosevelt pressed a solid gold telegraph key in Washington last month to formally open WLW, the world's largest radio station, he touched the same key President Woodrow Wilson tapped over 20 years ago to signal also the formal opening of the Panama Canal.

This famous telegraph key is kept at the White House, and is shown in an illustration in these columns. Little gold nuggets, which can be plainly seen around the edges, are mounted on a slab of Alaska marble from the first gold discovered in that territory. On the engraved plate is a statement that the key was presented to President Taft, for the purpose of opening the Alaska-Yukon-Pacific Exposition, June 1, 1908, by the discoverer of the gold, George W. Carmack.

Right, Inspectors trace "hootleg" amateur. Below, DeForest's "feedback" sketch.

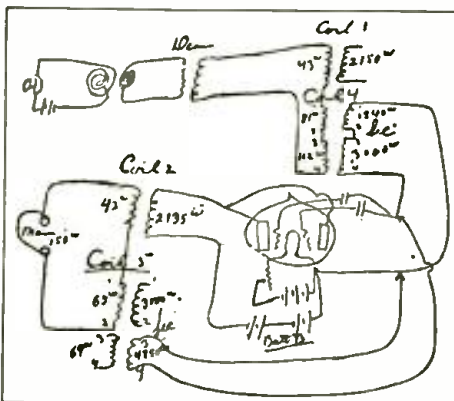



# IN REVIEW

Radio is now such a vast and diversified art it becomes necessary to make a general survey of important monthly developments. RADIO-CRAFT analyzes these developments and presents a review of those items which interest all.



Photo, Harris & Ewing  
Above, Gold key which when pressed by President Roosevelt formally opened WLW. Also served on many other historically important occasions.

## RADIO EQUIPPED PLANE WILL FIGHT CRIME FROM AIR

LAST month, a new Stinson monoplane was donated to the Nassau County police, Long Island, N. Y., as the nucleus of a new Crime Detection and Prevention Bureau. The plane is equipped with gas, smoke, and tear gas bombs, machine guns, searchlights, a radio receiver, radio transmitter, and a powerful telescope.

Because of this new instrument in the fight against crime, 100 county banks are installing direct alarms to the Nassau County Police headquarters, and the villages have turned over master control of all traffic lights to the county. Should a hold-up or major crime occur, the lights will be flashed red and kept that way until the police crew in this fast monoplane make a complete survey of traffic in the vicinity in an effort to apprehend the fugitive criminals.



Plane with two-way radio equipment to help arrest crime in Long Island

## TERRIER CARRIES PORTABLE RADIO FOR DOROTHY LEE

HAD any of our readers been in Hollywood last month, they might have seen the strange sight of a little wire-haired terrier to which a midget loop portable radio receiver was strapped. The dog is always accompanied by its pretty mistress, Miss Dorothy Lee, prominent radio star with RKO.

The receiver itself is extremely light, and is of the battery-powered type. The loop picks up the broadcast signals, and a small speaker, fastened on the other side of the dog, reproduces the program after it is amplified and detected.

This might be considered a novel publicity stunt to enhance Miss Lee's popularity, but it reminds us of a practical suggestion that was recently made, and is applicable in future wars. The idea was to employ police dogs as scouts to reconnoiter and determine the enemy's position. To each dog's back was to be strapped a miniature transmitter which would broadcast a continuous signal and, if captured by the enemy, their position could then be determined by directional receiving apparatus. A miniature receiver, also fastened to the dog, would contain a small loudspeaker which would issue commands, originating from "headquarters," to the dog.



Radio-equipped dog, and Dorothy Lee.  
Photo, Press Photos

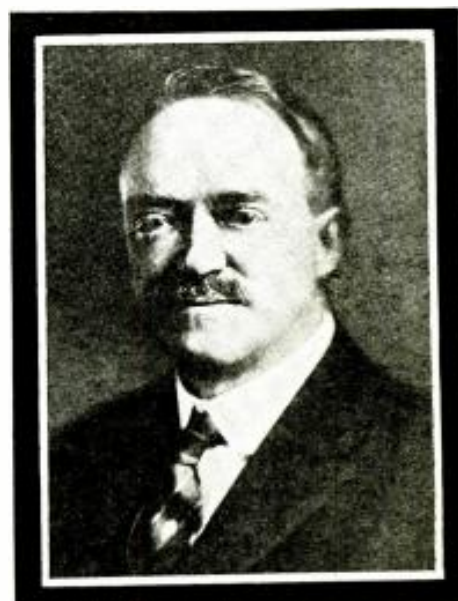

Dr. C. F. Jenkins passed away last month.

## C. F. JENKINS, TELEVISION EXPERT DEAD

ANOTHER great figure in the radio and associated industries has passed away. Last month, after being gravely ill since March, C. F. Jenkins, inventor of television and telephotography systems, died of heart disease. He was born near Dayton, Ohio, in 1867 of Quaker parents.

He had endeavored, up until almost the last minute, to supervise important experiments in his laboratory concerning a new development in a home-movie and sound-recording camera. As a matter of fact, before he became prominent in the television and radio field, he was an important figure and inventor in the motion picture industry.

He was founder of the Society of Motion Picture Engineers, and more than 400 inventions were accredited to his ingenuity. In 1925, Jenkins gave the first radio television demonstration at Washington before Secretary of the Navy Wilbur and other officials. In 1928 he inaugurated regular television broadcasts on short waves.

A great many of the engineering fraternity, who always admired and respected him, had pinned hopes on his bringing television to a successful completion so that it would be practical and available to the radio public.

His passing will be mourned by many.

# RADIO PICTORIAL

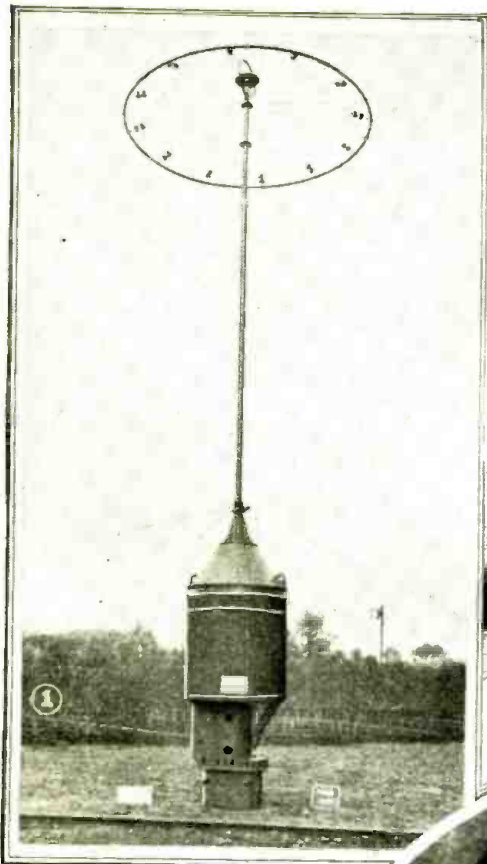

THE first "buoy radio beacon" ever constructed, and shown in 1, was invented by French technicians: Barbier Benard and Tereune Co. The transmitter is contained in the body of the float from which extends an umbrella-type antenna. The signals are sent out automatically for 2 minutes at intervals of every 10 minutes. It is claimed that a distance of 10 kilometers (approx 6.2 miles) in all directions can be covered, practically, with this arrangement. In 2 we see Cesare Sabelli in the radio room of the plane with which he and George R. Pond flew across the "big pond" from Floyd Bennett field, New York, to Ireland. Their destination was Rome, but, due to unfortunate circumstances, they were unable to make it. Want to talk to a plane? Well then, just dial. As you can see from photo 3, the instrument is similar and simple as the ordinary dial telephone. This aircraft radiophone switchboard, the complete equipment of which is shown in number 4, permits radio telephone operators to communicate with an airplane in flight by dialing the correct number. This system has been developed by United Air Lines. Much has been heard about "radia knives," used by surgeons for surgical operations, but few radio readers have ever seen the device. Photo number 5 shows the device in actual use in a large Berlin hospital. The principle employed involves a high-frequency current which will cut the tissues without destroying them in the same proportion as in the case of a knife. Also, with this instrument, the cut heals much more quickly, and reduces the loss of blood.

In 1, a buoy radio beacon invented by the French; 2, Cesare Sabelli, who recently flew across the ocean, with radio equipment in his plane that aided him in making a successful trip; 3 and 4, dialing 'planes in flight for verbal "contact."

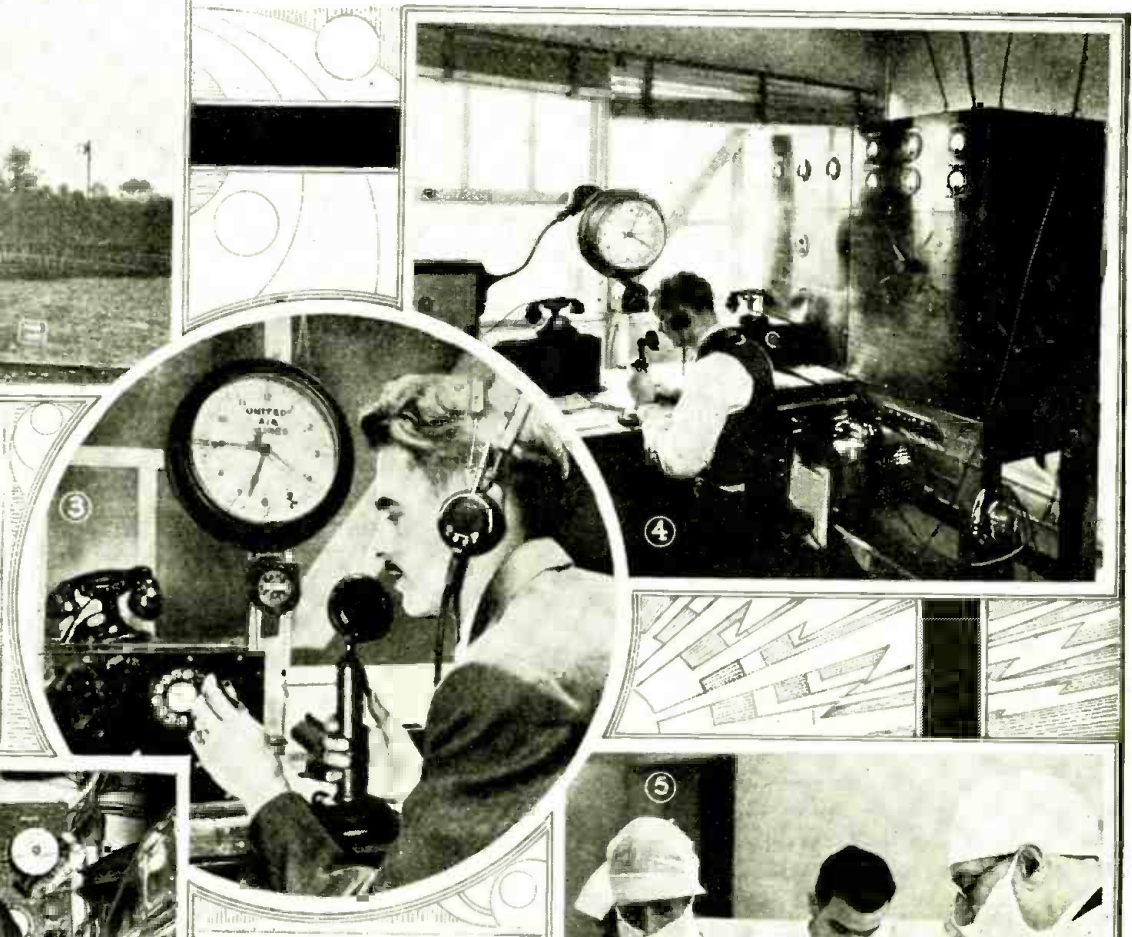

Also in 4, the radio equipment in use at one of the airports of United Air Lines; the airport radio operator dials the "plane by number to establish communication. 5, a "radio knife," employed for surgical operations, in actual use in a large Berlin hospital. This instrument is much more efficient than ordinary surgical knives. See text for explanation.

Photo courtesies, 1, Je Sals Tout; 2 and 5, Press Photos; 3 and 4, United Air Lines.

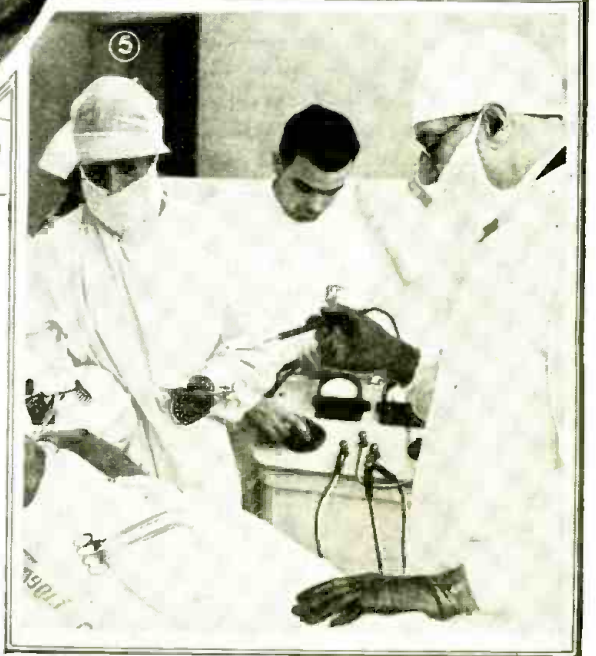

IN NUMBER 6, the net of aerials and the building housing the transmitter of radio station VCSPS, Moscow, Russia. A 500 kw. transmitter is employed, which indicates that the United States does not hold a monopoly on high-powered stations. In 7 is a view of the variometer employed for tuning the transmitter, and the cascade of large transmitting tubes of this transmitting station. In 8 we see an electron tube device for detecting flaws in copper tubing, wire or other similar material. The test is based upon the change in electrical resistance of a small section of tubing, which occurs when a defect is included within it. Two oscillators are coupled together and both tuned to the same frequency. As the metal tubing or wire passes through the machine, a flaw will change the frequency of one of the oscillators so that a beat note is heard in the loudspeaker, and a deflection seen in a meter. At 9 can be seen Dr. Thomas C. Poulter, second in command of the Byrd Antarctic Expedition, with a scientific "divining" rod. He expects to test for mineral potentialities in South Polar regions. When the sled-like apparatus is pulled across the snow, a buzzer sounds if it approaches metallic deposits in the earth. Dr. Poulter heads the science department of Iowa Wesleyan College, Mt. Pleasant, Iowa. One of the most unfortunate disasters occurred last May, when the liner Olympic sank the radio beacon ship Nantucket. The giant trans-Atlantic boat was approaching the shores of New England and being directed by the beacon signal sent out by the Nantucket due to a very heavy fog which had arisen. So perfect did the beacon signal direct the liner, and so accurately did the pilot of the big boat follow it, that before they could discern the fog-bound boat's outline or hear its powerful fog horn, they had run into and cut the boat in half. This beacon ship was a marker for ships approaching the coast from European ports, and was stationed 55 miles from Nantucket Island. It also served the purpose of warning ships, when weather was bad, against approaching too closely to shoals that had previously caused many ship disasters. In photo 10 the radio room and equipment of the Nantucket can be seen; and in 11 the complete ship with the radio antenna that sent out the disastrous beacon signal which guided the Olympic with such disastrous precision.

Photo courtesies; 6 and 7, Sovfoto; 8, General Electric; 9, 10, and 11, Press Photos.

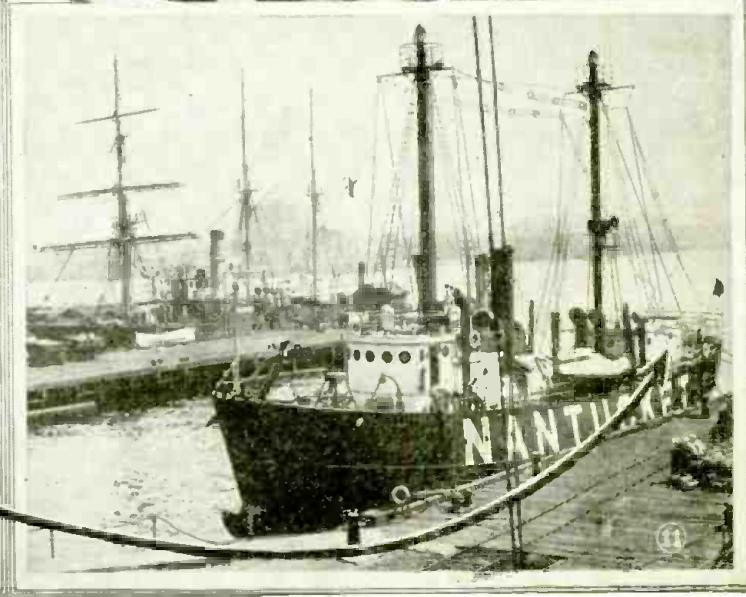
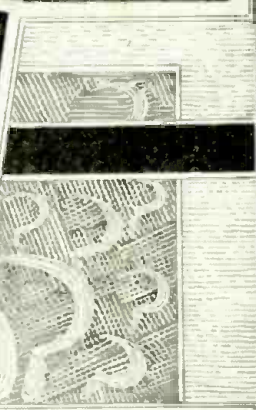
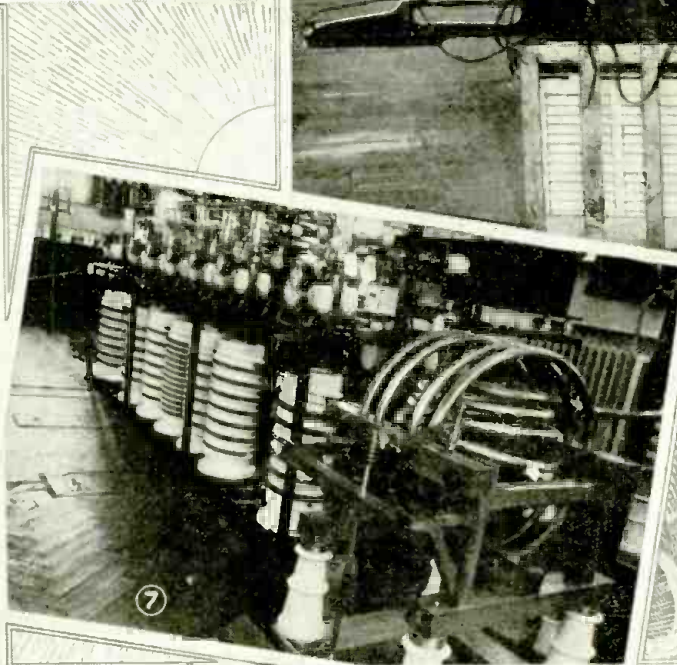
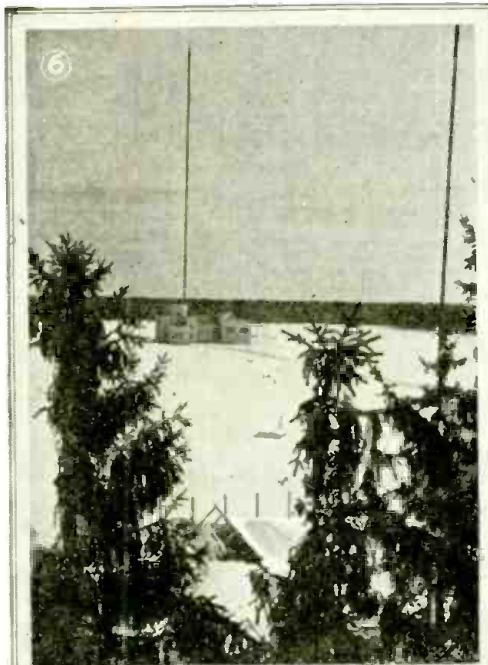
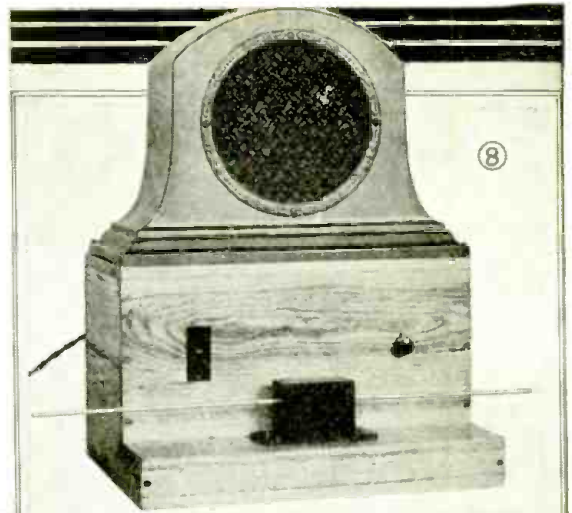

# THE LATEST RADIO EQUIPMENT



Above, all-wave antenna. (No. 496)

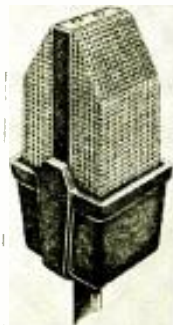

Center, velocity "mike." (No. 497)

Below, short-wave set. (No. 498)

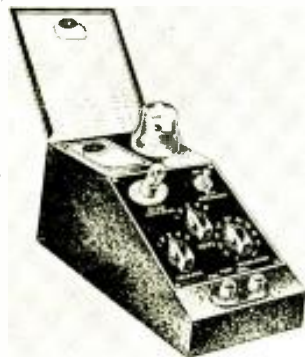

Condenser analyzer. (No. 499)

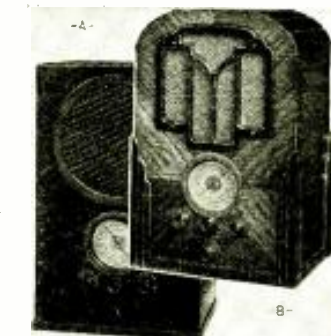

Beacon receivers. (No. 501)



Piezo-astatic pickup. (No. 502)

## EXCITER LAMP

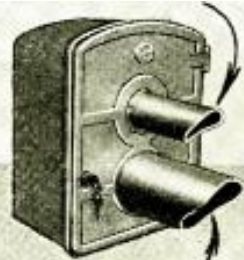

P.E. CELL

A P.E. cell relay. (No. 503)



A neon test lamp. (No. 504)



Under-rug antenna. (No. 505)

Left, a modern, all-wave set using the newest tubes. (No. 500)

## AN ALL-WAVE AERIAL KIT (No. 496)

INCLUDED in this newest kit are the following items: 2, 50 ft. coils of 7 x 20 stranded enameled copper wire; 75 ft. special "transposition-cable"; 25 ft. twisted-pair lead-in wire; 2, lightning arresters; 4, stand-off insulators; 2, nail-on knobs; 4, 3 in. glass insulators; 1, ground clamp; 2, 12 in. lead-in strips; 2 galvanized screw-eyes; 10 insulated staples. This kit, properly installed, will vastly improve all-wave reception in most instances.

## A RIBBON-TYPE VELOCITY MICROPHONE. (No. 497)

A NEW microphone with an output of approximately -90 db., and flat within 1 db. from 60 to 10,000 cycles. The magnets are 35% cobalt steel; the ribbon is hammered to .0002-in. thickness. The case is acoustically correct and sturdy.

## A NEW SHORT-WAVE SET. (No. 498)

THIS receiver is recommended to those who already have efficient broadcast receivers but who wish to enjoy the reception of long distance short-wave programs without the necessity of purchasing an entirely new set with all-wave features.

## A CONDENSER ANALYZER. (No. 499)

PAPER, mica, and oil dielectric condensers may be tested for leakage by using this new "condenser analyzer." Leakage current is shown by a neon indicator. Other faults such as open, intermittent, and short-circuits also may be located with this instrument.

## A NEW ALL-WAVE SET. (No. 500)

UNLIKE most all-wave sets that cover a complete spectrum this new receiver covers only the ranges of 18.5 to 55 meters, and 200 to 550 meters. This 5 tube set incorporates tone control and A.V.C.

## AIRPORT RADIO SETS (No. 501)

THE austere airport receiver shown at A is an 8 tube superhet. designed to cover the range of 150 to 18,000 kc. (2,000 to 16.6 meters) in 5 bands. The undistorted power output is 6 W. The chassis incorporates A.V.C. The cabinet blends well with rack-and-panel equipment.

The more decorative cabinet shown at B uses the same chassis-type described in connection with illustration A.

## A PIEZO-ASTATIC PICKUP (No. 502)

THESE new pickups have no pronounced peaks throughout the audio range. Standard lengths, 8 and 12 ins.; weight, only 2 ozs. Being non-magnetic they do not tend to collect magnetic particles, nor do they offer a magnetic circuit susceptible to electromagnetic fields.

## A LIGHT-SENSITIVE RELAY (No. 503)

THIS unit incorporates within it both the exciter lamp and the photoelectric cell, and operates on a 110 V. circuit. Visors permit the ray to be projected to a mirror 20 ft. distant and reflected into the light-sensitive cell. A compact, efficient unit having numerous commercial applications.

## A LAMP-TYPE TESTER (No. 504)

A CONTINUITY tester which operates from a light-line circuit. A neon lamp tests polarity, and high-resistance circuits; and a filament type, low-resistance. Its candelabra base may be used without the test leads as a night or pilot lamp.

## AN UNDER-RUG ANTENNA (No. 505)

THE objection to previous types of under-rug antennas has been that they raise the rug just sufficiently to make a ridge that soon shows wear. The metallized paper used in the under-rug antenna illustrated overcomes this objection. In addition, it provides a very large metallic surface of relatively low resistance.

## A SEMI-PROFESSIONAL RECORDER (No. 506)

THE 110 V., A.C. instrument illustrated is equipped with a volume indicator, volume control, off-on switch and a combination pickup and recording head. Turntable speeds: 33 1/3 and 78 r.p.m. Accommodates 12 in. to 16 in. blank aluminum discs. Impedance values: 400 and 5,000 ohms. Single and dual turntables are available for permanently recording radio or personal programs, etc.

Name of manufacturer of any device will be sent on receipt of a self-addressed, stamped envelope. Kindly give (number) in description under picture.



A sound recorder. (No. 506)

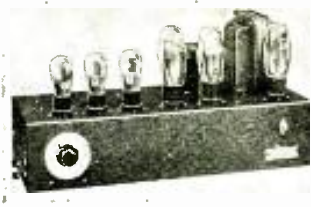

A 15 W. amplifier. (No. 507)

### A 15 W. POWER AMPLIFIER (No. 507)

THIS class A amplifier incorporates three 50s, two 2A3s and a 5Z5. A high-quality instrument; absence of A.C. hum is a feature. Input impedance: 200 ohms, with a third tap provided for a carbon microphone. Output impedances: 8, 16 and 500 ohms.

### A CONDENSER CAPACITY INDICATOR (No. 508)

THIS capacity indicator consists of a number of paper and dry-electrolytic condensers capable of withstanding surges up to 600 V., D.C. Capacity range, 250 mmf. to 16 mf. Circuits may be checked by the substitution method. This is a sturdy and well-built unit that should be in every service shop and "lab."

### A NEW AUTO-RADIO REPRODUCER (No. 509)

A FEATURE of this unit is its dome center cap which eliminates a spider construction and at the same time protects the voice coil and air gap against foreign articles. An acoustic filter assembly is built into this electrodynamic reproducer.

### AN A.C.-D.C. AND BATTERY ULTRA-MIDGET SET (No. 510)

THIS compact 4 tube set employs a T.R.F. circuit. The tuning range extends from the broadcast band into the police range. Weight, 6 lbs.; dimensions, 8 x 5 3/4 x 4 1/2 ins. deep. Utilizes one each of the following tubes: a 36, 39, 41 and 25Z5. A plug-in cable adapts the set to either 6 or 32 V. D.C. supply.

### A HIGH-SENSITIVE TEST UNIT (No. 511)

THIS is one of the first units to incorporate a voltmeter with a sensitivity of 2,000 ohms per volt. The ohmmeter section has ranges of 0-2,000-0.2-meg.-2megs; its battery supply is self-contained. The voltmeter range is 0-5-50-250-750. The milliammeter range is 0-50 ma.; the microammeter range is 0-500 microamperes. This unit is available in kit form.

### A WAVE-BAND SWITCH (No. 512)

SWITCHES have been the subject of continuous experiment. The unit illustrated is the latest development. Its features are definite indexing, sturdy construction, low capacity, compactness, single-hole mounting, silver-plated contacts, and grounded or ungrounded contacts. Available from S.P.S.T to 4 P.D.T.

### A 6 TUBE DUAL-WAVE SET (No. 513)

THE latest "fashion" in radio set design; it incorporates not only the domestic broadcast frequency range of 540 to 1,500 kc., but also the international channel of 3,400 to 15,350 kc. This 6 tube, 110 V. A.C. set uses two 588, one 2A7, one 2B7, one 2A5 and one 80. Tone control and A.V.C. are incorporated.

### AN ULTRA-SMALL, ROTARY-TYPE "B" UNIT (No. 514)

THIS compact motor-generator incorporates a reflex filter circuit. The input is 6 V.; the output, 350 V. Dimensions: 2 3/4 x 4 x 5 ins.; weight, 6 1/2 lbs. Its thrust ball bearings do not require oiling. The unit is available in A.C. or D.C.; also, for operation on 32 V. farm lighting plants.

### NEW "POLYIRON" INDUCTANCES (No. 515)

ALTHOUGH only an I.F. unit, with trimmers, is illustrated, "polyiron" inductances are available to manufacturers in types including regular R.F., inter-stage units, and R.F. and I.F. choke coils. (The available I.F. values are: 110, 175, 260, 370 and 465 kc.) Electro-magnetic coupling is employed. These new units are the first commercial types to appear in America incorporating the impalpable-iron core first described in the article, "Permeability Tuning," in the November, 1934, issue of RADIO-CRAFT. These devices are more efficient than air core units.

### TWO NEW PRODUCTS (No. 516)

To meet the demand for a 1 to 7 pole, 3 to 12 point gang switch for use in test apparatus and radio sets, there has been developed the shaft-insulated unit illustrated at A. The special-alloy contacts insure high conductivity and minimum wear; the contacts are positive and self-cleaning. Only highest grade bakelite is used. Suitable for use at ultra-short wavelengths. The meter shunts illustrated at B are accurate within 1 percent plus or minus. They are permanent in value and noiseless in operation. Combination lug and thumb terminals. Insulated to permit close mounting. Available in all popular resistance ranges; power rating, 1 W. Over-all dimensions: 2 3/4 x 3/4-in.

(Continued on page 113)



Capacity indicator. (No. 508)



A car reproducer. (No. 509)



A "convertible" set. (No. 510)



Sensitive voltmeter. (No. 511)



Wave-band switch. (No. 512)



A duo-channel set. (No. 513)



Tiny motor-generator. (No. 514)



Iron-core I.F. coil. (No. 515)



New radio components. (No. 516)

Right, 2 new tubes. The 1C6 "skeleton," A, is an "all-wave" tube. The 76, B, "matches" the 77 and 78. (No. 517)

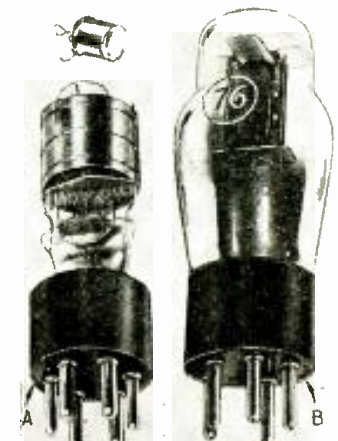

# AN IMPROVED "TREASURE" LOCATOR

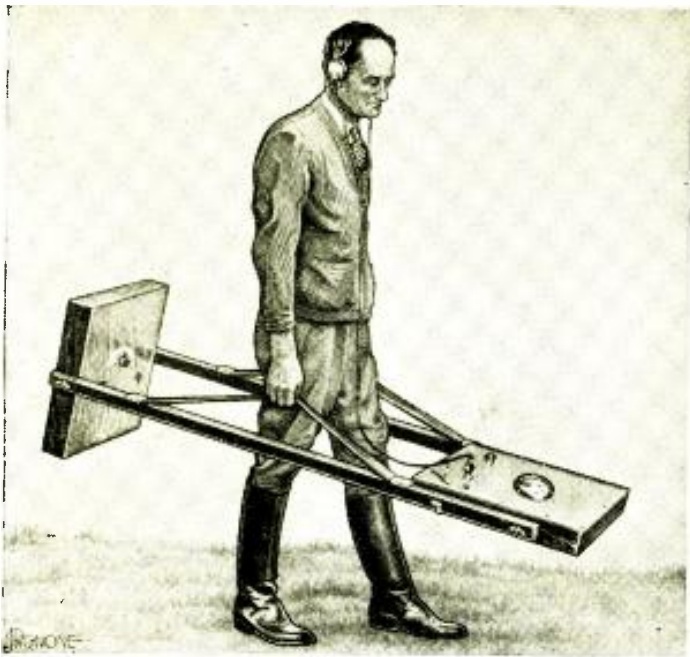

Photos, courtesy Radio Metal Locating Co.

From all over the world we receive letters from people interested in treasure locating equipment. Previous models described seemed to have been too complex in design and operation. The improved unit now described eliminates previous difficulties, its sensitivity permitting detection of a piece of metal 16 ins. square at a depth of 15 ft.

C. W. PALMER

SINCE the last description of a "treasure" locator (RADIO-CRAFT, July 1933), thousands of requests have been received from interested readers for additional information on a more simplified and less difficult-to-operate instrument. Because practical data on a locator having such characteristics were unavailable at the time, we have refrained from publishing any further information on this subject.

We believe that we have now an instrument that is about as efficient and simple as could possibly be made. Those who desire to construct it will find all necessary information contained in this article. (For those who prefer to save themselves the expense and trouble of

some little experimenting for adjustments, etc., besides the labor involved in constructing the unit, we add that the unit is commercially available.)

Some of our readers may not have read the previous articles on "treasure" finders (RADIO-CRAFT, July 1933 and June 1932) and perhaps are puzzled as to how a device of this sort can be useful for such purposes.

### Practical Applications of Metal Locators

This instrument will not "select" gold, or other precious metals, apart from baser metals, nor will any other similar electrical device. It will only indicate when any mass of metal is

sufficiently close enough to interfere with a delicate adjustment made within the receiver. It's usefulness is not limited to searching for buried treasure, but it can also be successfully used for the following:

- (1) Locating "lost" gas or water pipe lines. Municipalities that do not keep an exact record of the location of the various pipes will find that this instrument will save a great deal of unnecessary excavating.
  - (2) Locating metallic ore deposits or "pockets."
  - (3) For ascertaining whether sawblades, knives, guns, or other metal weapons are concealed upon the person
- (Continued on page 115)

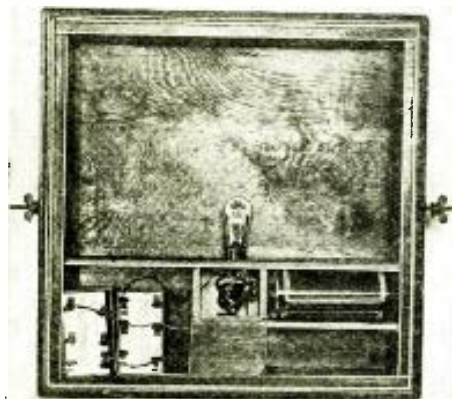

Fig. A  
Appearance of oscillator unit.



Fig. B  
Extra A.F. stage boosts signal.

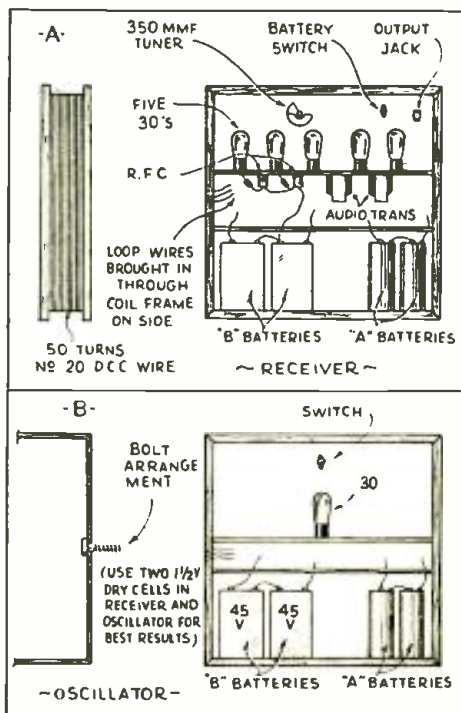

Fig. 2

Two separate frameworks are employed, the loops being built-in as shown above (all dimensions are given in the circuit diagram.)

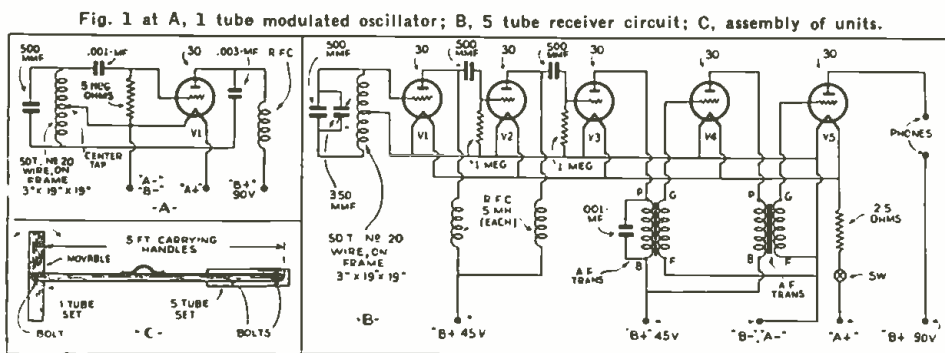

Fig. 1 at A, 1 tube modulated oscillator; B, 5 tube receiver circuit; C, assembly of units.

# A "SYNTRONIC" ORGAN

A new photocell "organ" which will produce organ music and tone qualities that have hitherto been impossible with the conventional instrument. While its internal construction seems a bit complicated, the principles employed are fundamental and can be readily grasped. In operation the device is extremely simple, so that a pianist as well as an organist can operate it without considerable training or practice.

EDWARD E. KASSEL

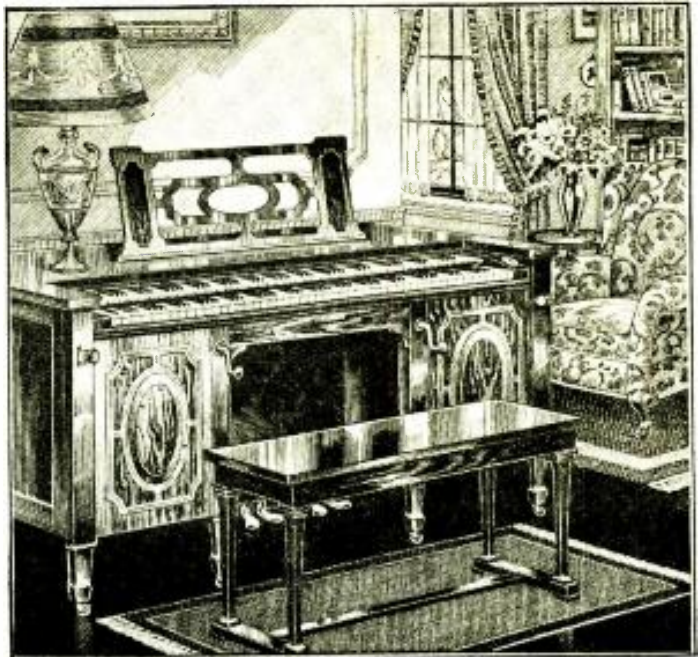

Fig. A. Two separate keyboards are employed, cranks shown change tone quality of each. A great variety of tones may be simulated.



Fig. B  
Analyzing wave form of various sounds.



Fig. C. above.  
Tones or "quality" being synthesized

Fig. D. below.  
Sound waves prepared for photographing.



**A** SYNTHETIC electronic organ has been developed in the electronic music laboratories of Ivan Eremeeff, Russian physicist and authority on electronic music, in the new WCAU Building in Philadelphia. The construction of this modern musical "giant," which is the last word in electronic music production, was made possible by the generous patronage of Dr. Leon Levy, President of the WCAU Broadcasting Company, and the able collaboration of Dr. Leopold Stokowski, Director of the Philadelphia Symphony Orchestra.

The electronic organ can well be classed as a universal musical instrument, since it embraces so many diverse types of musical tones, expressions, and effects. Not only producing its own unique tone characteristics, it is capable of producing the tones of other well known instruments, and the musical effects and expressions of the piano as well as the ordinary pipe organ. Thus, one may say that it is many instruments within an instrument, which is comfortably small and portable, thereby overcoming all the physical inconveniences of, for example, the huge, cumbersome, and expensive pipe organ.

The principles employed in Mr.

Eremeeff's methods of electronic music production are based on his own theories of sound synthesis, which are advancements on the theories by Hermann Helmholtz, German master physicist and mathematician. The universality of these principles enable Mr. Eremeeff to apply them in various forms, depending on the requirements and desires of those for whom they are made. Therefore, a person wishing for the tone quality and musical effects of a church pipe organ, for example and who does not care for or have room enough for the ordinary large pipe organ, will desire a small electronic organ in which are installed such parts that carry out the principles by which pipe organ music is produced. Then again, the broadcasting studio which is in need of music of varied tone qualities, such as the tone of the violin, the flute, the saxophone, the oboe, etc., or, in other words, music for every occasion, will desire an electronic musical instrument which functions on the principles by which such varied music is produced.

### Simulating Sound

In order to understand the construction and operation of the Eremeeff syn-  
(Continued on page 104)

Fig. 1  
The construction of the organ is shown in this figure. See text for explanation.

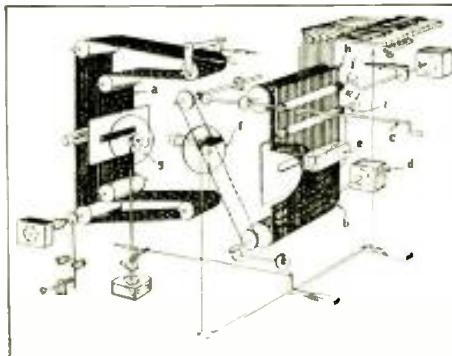
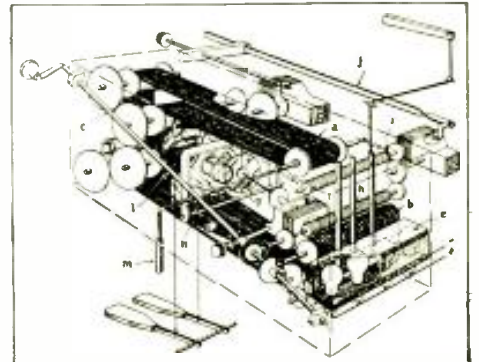

Fig. 2  
This is a single unit of a commercial assembly; includes keyboard, pedals, etc.



# SURGICAL-ROOM SOUND INSTALLATIONS

J. T. BERNSLEY

**P**UBLIC address installations now facilitate the instruction of student surgeons in hospitals on both coasts, by enabling the distant surgeon or one of his assistants within the operating room to describe each vital move during the progress of a delicate operation. The manner in which this is accomplished, as illustrated in the photographic illustrations on this page, is an absorbing story whose details and money-making possibilities until now have not been known or realized by most technicians and Service Men.

Dr. Chaffee, chief surgeon in a Los Angeles hospital is shown in the "action" view, A, performing a major operation while at the same time he delineates its intricacies for the benefit of surgeons assembled outside the sound-proof operating room. This running description, picked up by a microphone concealed in the sanitary face mask which he must wear, is carried to a remote rack-and-panel type amplifier, the output of which feeds reproducers suitably located in the observation gallery.

## A Medical Center (N. Y. C.) Surgical Room Sound Installation

To continue the analysis of hospital public address installations the reader is transported from California to New York where, in the Eye Hospital at Medical Center, New York City, we find radio-type vacuum tubes again serving in a humanitarian role. It was impossible to obtain an action picture at the Center as the camera was considered, in medical parlance, "contaminated," and not to be permitted in a room where lives depend upon *absolute* cleanliness.

Since ordinary "studio"-type microphones placed anywhere in the room picked up every noise produced in the operating room, it remained for the lapel-type microphone, shown at B, to make practical the installation in hospital operating rooms of sound apparatus that would permit the low tones of a surgeon to be picked up during an operation.

How 16 students may be grouped around the sound-proof and plate-glass enclosed amphitheatre in Medical Center's Institute of Ophthalmology, is shown at C. Binoculars enhance the vision, but it remains for the reproducer set flush in the ceiling as shown at D, to acquaint the students, in the sound-treated gallery, with the operation's important details as they develop.

In a separate room is located the rack-and-panel amplifier equipment, illus-

Sound installations in operating rooms of hospitals are now practical, and facilitate instruction of student surgeons.

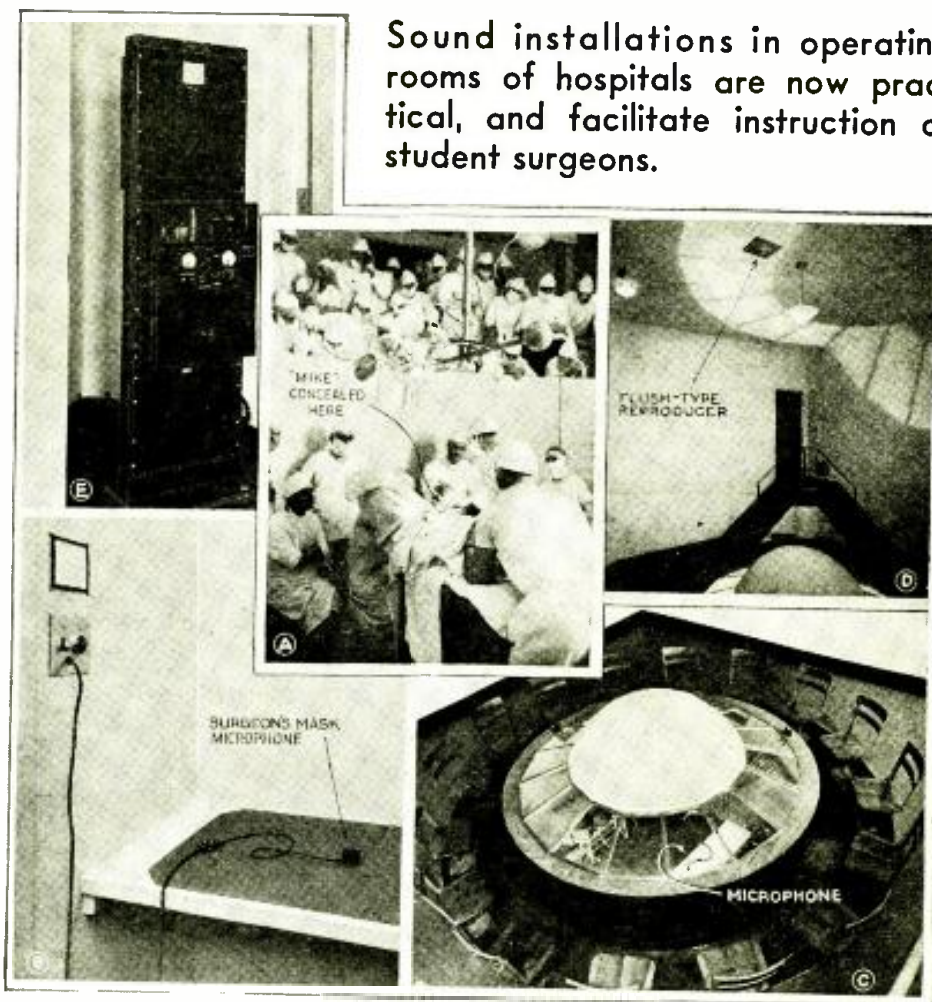

Above  
Dr. Chaffee (seated) describes an operation. A. Another hospital uses "mike" B, in amphitheatre C, with ceiling speaker D, and amplifier E.

trated in E, to which the microphone wall-plates are wired, and from which lead the reproducer connections. For, the system is so designed that the students in the observation gallery may be given instruction by a speaker in an ante-room before those in main room are ready to begin the operation.

## Construction of a Lapel-Type Microphone

As the single-button "lapel"-type microphone is the "heart" of the installation, its technical features will be discussed, with particular reference to Fig. 1.

There are five essential factors that enter into the satisfactory operation of the lapel-type microphone in this type of installation; (especially, if it is to be used underneath a surgical mask). These are: (1) the soft-rubber casing; (2) the diaphragm; (3) the carbon chamber; (4) the bypass condenser;

(Continued on page 103)

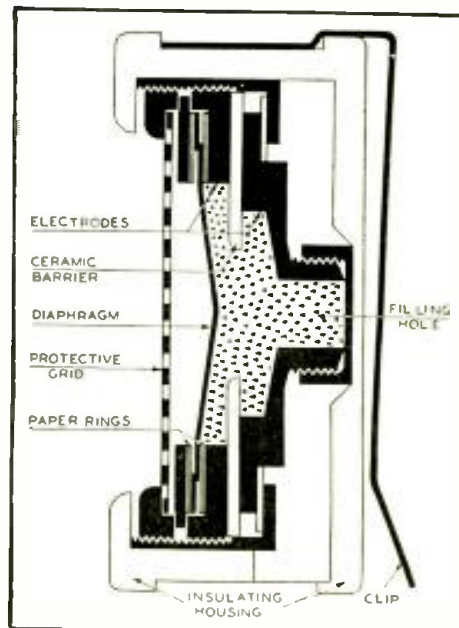
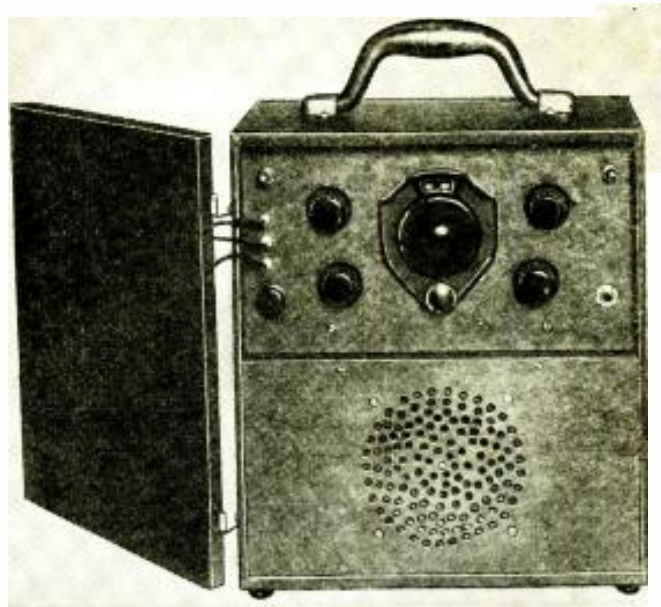

Fig. 1  
Cross-section view of a lapel-type microphone. The special construction that enables this type of microphone to function properly is clearly shown.



# A WELL-DESIGNED 5 TUBE PORTABLE



A portable receiver will always help fill any lull in recreational activities, when on a vacation, picnicking, or a week-end trip to the country. The portable described here is extremely sensitive, employs few tubes, and is very economical in "A" and "B" battery consumption. It is loop operated.

R. M. DEAN



Fig. B. Rear view of receiver and batteries.

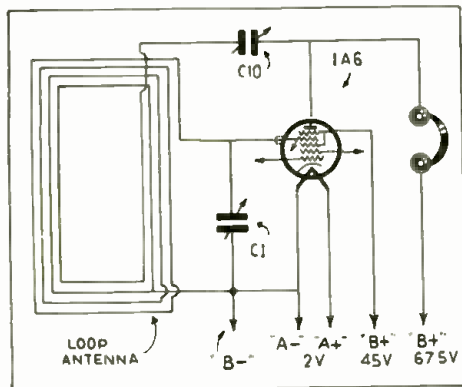

Fig. 1. Loop circuit for adjusting set.

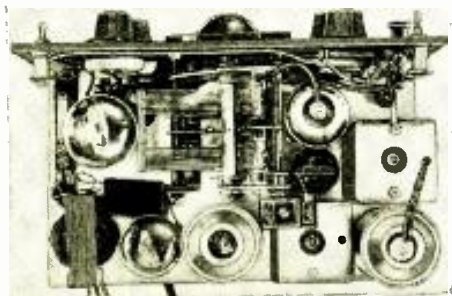

Fig. C. Location of parts on receiver chassis.

PORTABLE receiver design is largely a matter of compromise, since compactness, simplicity, ruggedness, and light weight are desired on the one hand; while high sensitivity, ample volume, good tone quality, and economy of operation are desired on the other. For this reason it is best for the constructor to work out his own design, after deciding what factors he thinks most important. In the receiver illustrated here the chief considerations were high sensitivity and long battery life with only moderate volume output. Because it was desired to experiment with controlled regeneration and A. V. C. the panel has a somewhat crowded appearance. After a discussion of the factors involved in radio construction as they relate to portable design, a description of this receiver will be given.

Due to the very limited demand for the portable radio set, neither the commercial manufacturer nor the set builder has given it much attention. It is not proposed to write here a defense for the portable set. In spite of its drawbacks and limitations the portable has a place in the radio field and, in addition, a unique fascination all its own. So anyone willing to devote the care and effort necessary to making one will, I'm sure, feel amply repaid. The elements

of design are more or less inter-related, but they can be conveniently divided into three groups.

(1) Type of tubes, power supply, and economy of operation.

(2) Sensitivity and selectivity.

(3) Tone quality and power output.

## Tubes and Batteries

If it were not for the high filament drain the 6 V. heater tubes would be the obvious choice. When the receiver is used only occasionally, such as a few hours a week during the summer, this doesn't matter, for one or two sets of dry cells would last the season. But if frequently used the replacement of the "A" battery every week or two becomes a nuisance and an expense. In the "old" days of radio '99s were used in portables with fair satisfaction. The newer 2 V. tubes are more rugged and less microphonic besides being more efficient, so if reasonable care is exercised in handling the set good results can be expected.

Four dry cells in series will be used as "A" supply where 6 V. tubes are used, or if longer life is desired, five cells with a suitable resistor. Two dry cells in series or a small 3 V. "A" pack with a regulating (ballast tube) or non-

(Continued on page 125)

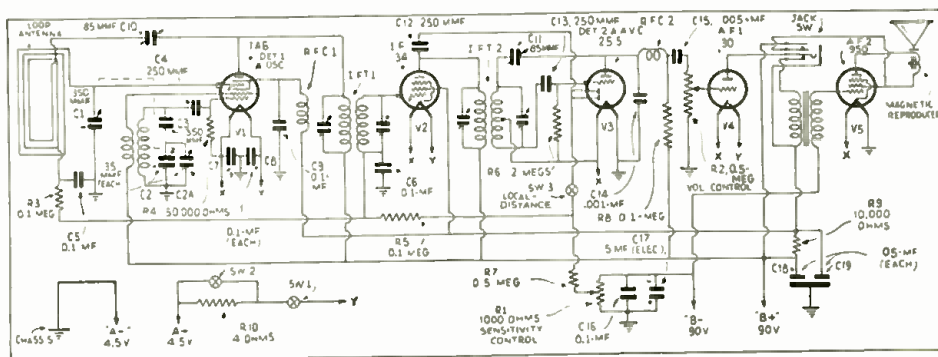

Fig. 2

Schematic wiring diagram of 5 tube, dry-cell type, super-het. portable.

# BROADCASTS



A directional-loop installation in a Stinson Reliant airplane.  
(Washington Inst. of Technology Photo)

Every radio transmitting station is a "beacon" to the pilot whose airplane is equipped with the new single-loop antenna radio direction finder. 788 such "beacons" are ready to guide him to his destination, whether it lies near a radio broadcasting station or not. The radio page of his local newspaper is his map, and he can set his course toward any station, or find his location by taking radio bearings on two stations.

**I**n last month's issue of RADIO-CRAFT we told how radio beacons guide our air liners on their courses. There are now 92 such beacon stations, serving our major air lanes (Fig. 1). They are the backbone of our commercial and military flying; but the private pilot off the beaten track would often find himself in a location not served by these beacons.

This new radio direction finder gives the pilot his direct course toward any radio broadcasting station which he can tune in on the receiving set. Thus, the pilot of an airplane equipped with such a set has at his disposal 788 true "compasses" dotting the country: there are 592 commercial radio stations, 92 Department of Commerce airway radio beacons, and 104 marine range beacons along the coasts and the shores of the Great Lakes. With their aid, he can always bring his ship to any point on the continent, whether there is a radio station at his destination, or not. The pilot can always locate himself by merely tuning in on two stations, read his compass, draw two lines according to the indicated bearings, and mark the point on his map where the two lines cross.

What is equally important, the radio direction finder can be used equally well anywhere in the world, for there are broadcast stations everywhere.

In long distance flights, the finder is especially useful, as it always guides the pilot along a great circle route, which is the shortest distance between two points on a sphere, like our earth. Wiley Post, who last year girdled the globe, alone, in 7 days, 18 hours and 49½ minutes, used one of the first experimental models developed by the Bureau of Standards, and was enthusiastic in his praise of this device. It relieved him of the arduous task of making observations with a sextant, or even computing compass bearings, while piloting his speedy Lockheed. The radio direction finder brought him unerringly to his destination all the way around the world.

The reception of radio signals is visual, and the course toward (or away from) the radio station is indicated by the pointer of a zero-center type course indicator. At will, the pilot can both listen to broadcast and at the same time have his direction shown on the course indicator.

This radio direction finder, like the

airway beacon and the blind landing system, was developed by the Bureau of Standards of the Department of Commerce. A commercial version of this direction finder, called the "Direct-Aire," which can be connected to any standard receiving set, (photo below) has recently been placed on the market by the Washington Institute of Technology.

The simplicity of its operation, its low weight and low cost, and its tremendous value in the operation of aircraft, render this appliance of particular interest to the radio man, as it will undoubtedly soon find the way into most of the private airplanes in use, and also into many water craft as well, where it can be used to equal advantage. Again a new field is opened to radiomen.

## Principle of Operation

The direction finder requires the use of a single-loop antenna, the bi-directional field pattern of which is distorted, and periodically switched, so that the larger lobe of the distorted field pattern lies first on one side of the airplane, and then on the other (Fig. 2C).

The normal figure-of-eight field pattern of a balanced loop antenna can be converted into a cardioid, or a heart-

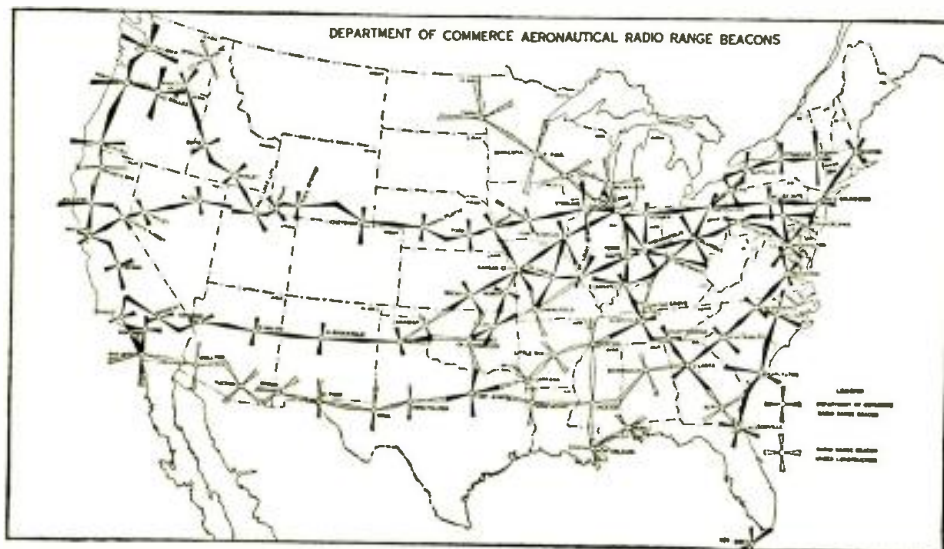

Fig. 1, left  
Beacons serve only the major air routes.

Below  
The Direct-Aire mounted alongside a Lear aircraft receiver makes a compact unit.



# GUIDE AIRPLANES

This latest application of radio aids to aviation is intended primarily for the sportsman pilot whose destination usually lies away from the major air routes served by radio beacons. This important contribution to flying, recently developed by the Bureau of Standards of the U. S. Department of Commerce, is now available commercially. Radio again adds another milestone in the progress of aviation, our youngest and the most promising industry.

HENRY W. ROBERTS

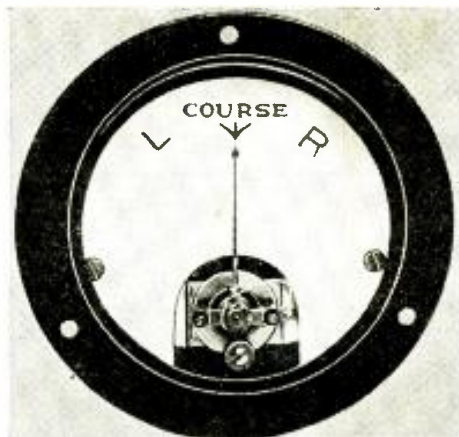

(U. S. Dept. of Commerce photo)  
The zero-center type course indicator tells the pilot at a glance whether he is on course.

shaped pattern (Fig. 2A), either by introducing a vertical antenna (the vertical antenna current being 90 degrees out of phase with the loop antenna currents, or in phase with their resultant); or by utilizing the vertical effect of a loop antenna not symmetrical with respect to ground. If perfectly phased patterns in such a loop antenna are required, careful adjustment of its tuning is necessary; on the other hand, patterns similar to that shown in Fig. 2B are readily secured, the smaller lobe of the field pattern resulting from a phase angle between the vertical effect and the loop antenna effect.

With the loop set at right angles to the fuselage, the intersections of these distorted field patterns lie directly ahead and behind the airplane (Fig. 2C). The field patterns are switched electrically, by grounding the ends of the loop antenna through two rectifier tubes to which an alternating voltage is applied, so that they pass current alternately, as shown in Fig. 3.

The course indicator is connected in the cathode-return leads of the rectifier tubes, so that the current of the rectifiers passes through in opposite directions. The course indicator is switched

synchronously with the loop patterns, and when the larger lobe of the pattern is to the right of the airplane, the signal received deflects the pointer of the course indicator to the right, and vice versa. The audio output of the finder is applied to the rectifiers, and the currents so produced are proportional to the field patterns. As long as the airplane points directly to the radio station, the alternate deflections of the pointer remain equal, and the pointer appears to remain in center or "on course" position. The "switching" is done many thousands of times a second, and the eye does not notice any vibration of the indicator pointer. When the airplane heads away from the true course, the prevalence of signals received from one side results in a difference in voltages developed by the two field patterns, and causes the indicator pointer to deflect, warning the pilot that he is "off course," and to which side. A reversing switch can be provided for obtaining correct indication when flying toward or away from a radio station.

ment of the single-loop antenna radio direction finder, as developed by the Bureau of Standards. Loop antenna L1 is tuned by condenser C1; the incoming signals are applied to the first R.F. amplifier between the center point of the loop antenna and the ground. The ends of the loop antenna are connected to the rectifiers V1 and V2, through equal condensers C2 and C3. An alternating voltage is applied in opposite phase, through R.F. inductances L2 and L3, to the plates of the rectifiers; this voltage should be of a frequency readily passed by the audio amplifier of the radio receiver used in the installation. The cathodes of the rectifiers are connected through resistor R1; the adjustable center-tap of the resistor passes through the audio output transformer of the radio receiver to ground. The course indicator, M, is connected across this resistor, and a high-capacity low-voltage electrolytic condenser C5 damps the course indicator.

The voltage to the rectifiers is supplied by an audio oscillator, T1, using vacuum tube V4 with tuning condenser C4. Resistors R2 and R3 serve as a voltage divider, and are matched to

(Continued on page 103)

### Arrangement of Circuit

Figure 3 shows the circuit arrange-

Fig. 3, right  
Circuit diagram of U. S. Department of Commerce single-loop antenna radio direction finder.

Fig. 2, below  
The normal figure-of-eight pattern of a loop antenna can be modified by introducing a vertical-antenna effect.

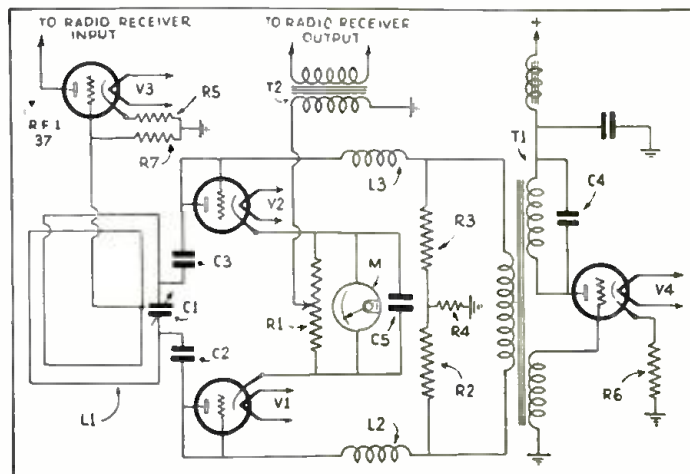
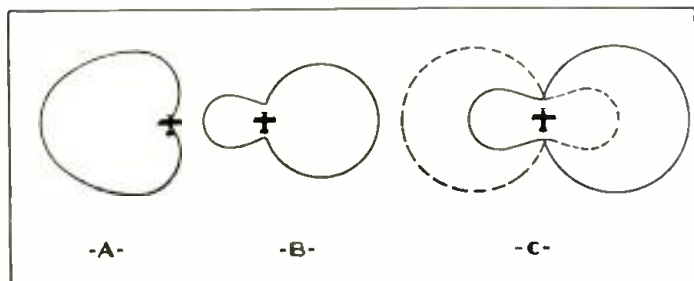

# INTERNATIONAL RADIO REVIEW

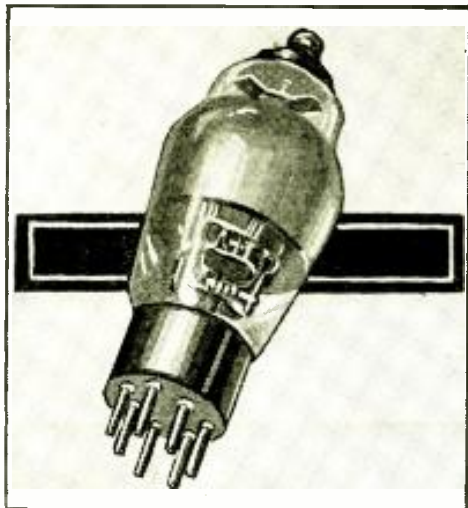

Fig. A

The new English duo-diode-pentode output tube.

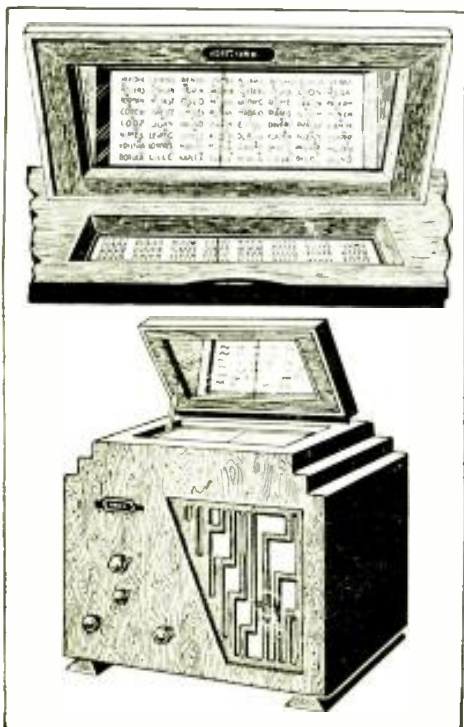

Fig. B. above

Two speaker units provide full room coverage.

Fig. C. below

The mirror tuning dial—A French invention which introduces a novel cabinet design.



HERE is what the radio experimenter has been wanting for a long time—a semi-technical review of the thousands of new ideas which are continually appearing in overseas publications. Each month there are received at the offices of RADIO-CRAFT hundreds of daily, weekly and monthly magazines originating from all over the world.

SINCE the cost of subscribing to each of these would be prohibitive for most radio men, we have arranged with technical translators to prepare for our readers reviews of all the really important, new developments illustrated and described each month in these publications.

NOTE that the only available information is that which is published; the experimenter must adapt the ideas to whatever equipment he has on hand.

## A DUO-DIODE OUTPUT PENTODE

NEW tubes seem to be the fashion in radio today and our European cousins are certainly not far behind us in the development of new types. The tube shown in Fig. A, is of a new composite variety designed primarily for midget sets. It contains both a duo-diode detector and a pentode output section. By the use of this tube, sets which employ only one A.F. stage can conserve one tube by the use of this double duty tube.

While we have numerous composite tubes in this country, this particular variety will be new to American readers. It is pointed out in the descriptive material which appeared recently in WIRELESS WORLD that by its use in conjunction with a pentagrid frequency converter, and one additional tube as an I.F. amplifier, a 3 tube superheterodyne of practical design can be manufactured. Such a set can combine such features as A.V.C. and interstage noise suppression, due to the flexibility of the diode output pentode.

## NOVEL CABINETS

EUROPEAN manufacturers place on the market from time to time, novelties in cabinet design that appear "different" to the American radio fans. The cabinet at Fig. B which appeared recently in the BROADCASTER AND WIRELESS RETAILER, an English trade magazine, shows the use of 2 balanced loudspeakers to facilitate "full room" coverage.

This set is housed in a table-model cabinet with a front panel containing tuning and volume controls and with

2 off-set panels in which the reproducers are mounted.

Another novelty in cabinet design which appeared in RADIO MAGAZINE, a French publication, is shown as Fig. C. This consists of a cabinet in which the tuning dial is located on the top instead of in the usual position on the front panel. A cover conceals this dial when the set is not in use and when the cover is raised, a mirror is found on its inner surface. This mirror reflects the image of the recessed dial and because of its large size, the station call letters or locations (in Europe the city is often used to identify a station) can be scribed directly onto the dial. A thin pointer moves across the dial to indicate which station is being received.

The set contained within this cabinet is modern in design, and includes such features as automatic volume control, interstage noise suppression and all other features that make up a modern receiver.

## MORE NEW TUBES

THERE seems to be no end to the number of elements that can be inserted within one small glass bulb. We were all startled when the pentagrid frequency-changer tubes, such as the 2A7 and 6A7 were placed on the market but apparently tube manufacturers in Europe are not yet satisfied with the present complement of tube designs. A new tube known as the "octode" was recently described in TOUTE LA RADIO, a French magazine. The octode is a further development of the pentagrid converter tube and contains an additional suppressor grid between the plate and the fifth grid, which is internally connected to the cathode. This additional element has several effects upon the operation of the tube. In the first place, a tube constructed in this manner has a much higher conversion-amplification factor than previous types and is entirely free from the critical operating points found on certain frequencies with the ordinary pentagrid converter tubes. Also, this tube will operate on much lower wavelengths than previous types, being quite efficient on wavelengths as low as 7 meters. A typical circuit for the new octode tube is shown in Fig. 1 and it will be noticed that it is very similar to the circuits advocated for ordinary pentagrid converters.

Some time ago we displayed a new English tube which was peculiarly christened "Catkin." This tube was constructed after the fashion of the large, air-cooled types used for radio transmitters in which a copper-to-glass seal was substituted for the usual glass envelope. (RADIO-CRAFT, August 1933, page 75).

The latest developments of the Catkin series of tubes are designed for battery operation. The construction of

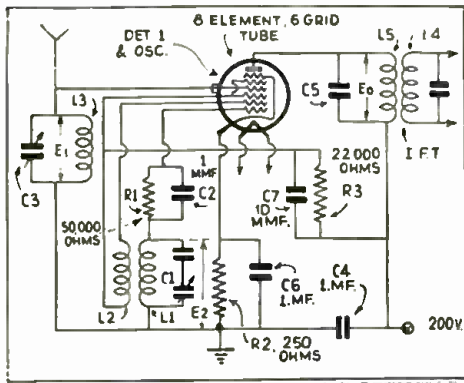

Fig. 1  
The frequency-converter circuit for the new "octode."

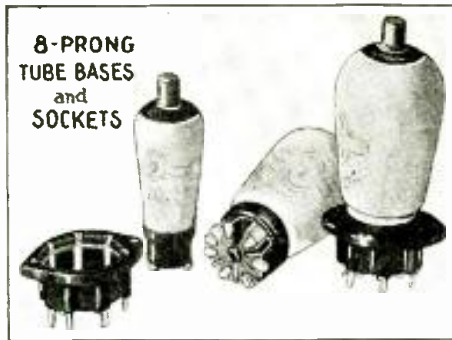

Fig. D  
These 8 contact tubes and sockets employ side instead of base terminals, for prong and socket connections.

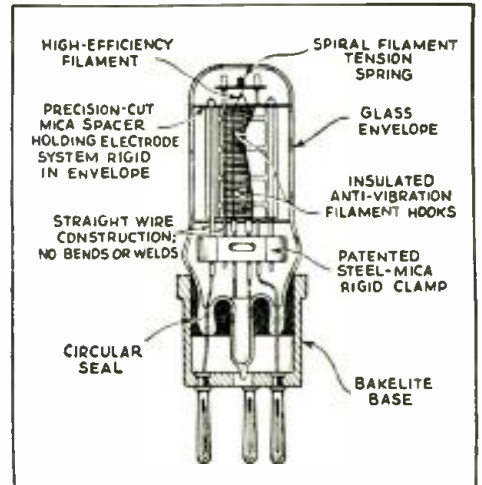

Fig. 2  
The construction of the battery "catkin" tubes.

these tubes is somewhat different from the original Catkins, as shown in Fig. 2 although small size and rigid construction are the results of this variation in tube manufacture.

Last month we showed a picture of a new midget tube which had just been introduced by the Marconiphone Co., Ltd. As it will be remembered, this new tube was exceptionally small in size and economical in battery requirements.

A further examination of this midget tube showed that no contact prongs were used on the base. At that time, we predicted that this method of tube base construction would find wide use on both the European and American markets. In Fig. D. are shown several new types of English construction which have just been shown in the BROADCASTER & WIRELESS RETAILER. They employ the same type of tube base construction as the midget tube mentioned above. Also, these tubes are 8 contact types which illustrates how many contacts can be placed around the circumference of this new type of tube base.

### REAL LIFE REPRODUCTION

SEVERAL issues of POPULAR WIRELESS magazine recently have contained descriptions of a new system of reproduction that it is claimed brings back certain characteristics, which are present

in actual renditions of instrumental music but are usually missing in radio reproduction. The system is a development of G. V. Dowding, Technical Editor of the above magazine. Mr. Dowding found that the main difference between hearing instruments, and reproductions of these instruments, is the loss of those very low frequencies which are "felt" rather than "heard." Those who have attended symphony concerts, are familiar with these extremely low frequencies and while it is technically possible to reproduce them, with present-day radio transmitters and receivers the amplitude of these "infra-sonic" frequencies is attenuated a great deal.

In order to compensate for this loss Mr. Dowding artificially compensates for these low frequencies by the introduction of a special amplifier system. This amplifier works on an inverted A.V.C. principle so that any increase in the bass response of the receiver is brought out by the "infra-sonic" amplifier. While this is an artificial means for arriving at the desired result, those who have heard the new amplifier in operation claim that the difference between reproduction and actual instruments can not be detected.

The "infra-sonic" amplifier combines a dynatron oscillator which creates the "infra-sonic" frequencies, with an audio

(Continued on page 109)

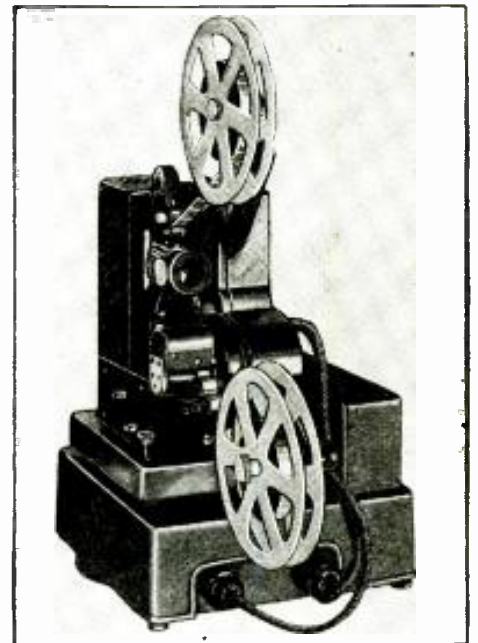

Fig. E, above  
Here is a new German 16 mm. sound-film projector, amplifier and reproducer.

Fig. 3

The "infra-sonic" system of "real-life" reproduction. A dynatron oscillator generates the sub-audible frequencies which are amplified by a D.C. amplifier.

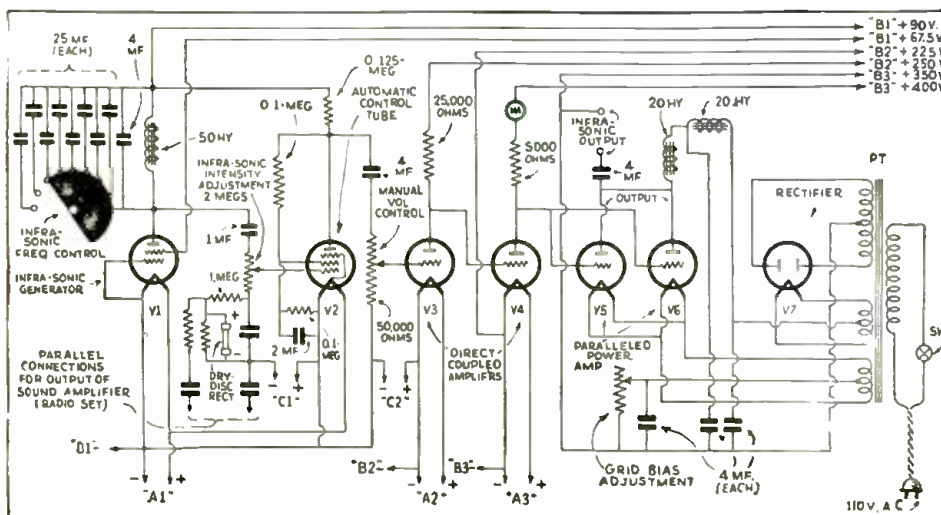

Fig. F, below  
Three tuning dials are used for the long, intermediate, and short-wave broadcasts.



# IMPORTANT FACTS ABOUT THE NEW ALL-WAVE ANTENNA SYSTEMS

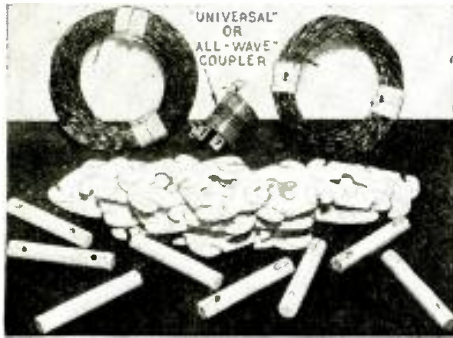

Fig. B  
"Transposed lead-in" antenna kit.

In this article the author continues his discussion of new antenna systems especially designed for use with all-wave radio sets. For highest efficiency, modern all-wave sets must be used with modern antennas.

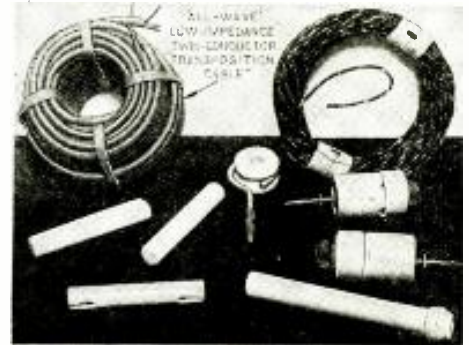

Fig. C  
"Transposition-cable" antenna kit.

R. D. WASHBURNE

PART II

RADIO set owners should realize that although their set has limped along with an antiquated, "hay wire," and inefficient aerial, the application of modern ideas in antenna design will greatly improve even their old, 200 to 550 meter set operation; and that, in the event they own, or contemplate purchasing a new set, a modern design of antenna system is necessitated by the high efficiency of late radio receiver models—most of which are capable of receiving at least police-band signals and, in many instances, wavelengths as low as 15 meters.

For this reason Part I of this article described the fundamental principles upon which these new antenna systems are based. The first system to be considered in more detail was the new "double doublet," which was illustrated in Figs. 1 and A. Now go on with the story.

### Limitations of Early-Type Antennas

(2) Inverted-L With Unshielded Lead-in. In Fig. 2 is illustrated our old stand-by, the "inverted-L"-type antenna. Where does this design fit into the all-wave antenna picture; what are its uses and limitations?

When correctly installed, excellent all-wave operation may be obtained—*provided* the local-noise level is extremely low. In other words, this antenna system can only be recommended to the rural-ite living in a location remote from sources of man-made interference.

The best means of supporting the antenna is by two *rigid* poles, one preferably on the house and the other mounted about 40 or 50 ft. away, so that the antenna is clear of the ground by the greatest distance. A metal roof underneath the antenna wire will tend to reduce its efficiency somewhat. Trees are not desirable supports for an *all-wave* antenna, owing to their tendency to sway and cause fading, as well as their tendency to absorb energy and thus reduce the signal strength. If located close to a road, or with the down-lead end toward the road, excessive interference from automobile ignition systems may be experienced on the shortest wavelengths.

As recommended in past issues of RADIO-CRAFT, experiment carefully to find the best antenna "spot."

It is *very important* that the horizontal span be as far as possible from chimneys, walls, trees, or any other wires; the lower or vertical section should also be kept "in the clear" and well away from rainspouts, telephone or power wires, tree branches or any other foreign objects; the lead-in or down-lead section should not approach the side of the house closer than about 6 ins. These points are brought out by the illustration, which should be carefully studied.

### The Antenna a Continuous Wire

Note that the antenna wire should be in one continuous length from the far insulator, through the house-end insulator marked "insulator," and so on to, and through, the stand-off insulator. To keep the lead-in or down-lead section of the antenna system from sliding back and forth in the stand-off insulator a tie-wire may be used, as shown. The lightning arrester is mounted on the outside of the house in order that its ground post may be run directly to a "driven" ground. This is made by driving a 5 or 6 ft. metal pipe or rod into moist earth, leaving above-ground only about 6 ins. of the pipe or rod, to which the ground wire can be *securely* fastened by means of a good ground clamp.

For the antenna use at least No. 14 B. & S. stranded copper wire, and No. 12, if possible. Keep the antenna and ground leads well apart at all points. Locate the radio receiver as close as possible to the point at which the antenna enters the house.

(Reference to Fig. 8 indicates that antenna lengths 25-30 ft. or 100-105 ft. may be used for reception of frequencies within the "good" sections. However, although either length is optional, use the longer one to favor broadcast-band reception, or if part of the building shields part of the antenna system.)

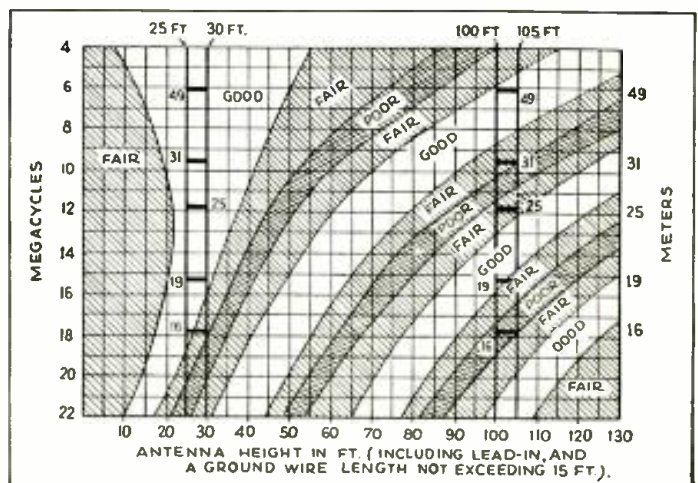

Fig. 8

A graph illustrating comparative set and antenna efficiencies. The unshaded areas show good antenna action for the antenna lengths and resultant natural frequencies indicated, for a particular all-wave set.

## HOW TO IDENTIFY THE FOREMOST OVERSEAS BROADCAST STATIONS

Most foreign short-wave stations announce in several languages, including English. However, numerous stations have characteristic signatures, the most important of which are listed below:

- CNR—RABAT, MOROCCO, AFRICA (8,050, 9,300 and 12,830 megacycles; 37.3, 32.3 and 23.4 meters, respectively); 12 kw. Announces "Radio Rabat dans Maroc." Uses beat of metronome (tic-toc, tic-toc) in intermission.
- TLAA—LISBON, PORTUGAL (9,590 and 15,340 megacycles; 31.3 and 19.6 meters, respectively). Six cuckoo calls between selections.
- DIA to DJD—ZEESSEN, GERMANY (9,560, 15,200, 6,020 and 11,760 megacycles, respectively); 31.4, 19.7, 49.8 and 25.5 meters, respectively; 5 kw. Signs in English, Spanish and German. Plays characteristic eight-bar chime selection during intermission.
- EAQ—MADRID, SPAIN (10,000 megacycles; 30 meters); 20 kw. Signs in English.
- FYA—PONTOISE, FRANCE (11,705, 11,905 and 15,240 megacycles; 25.6, 25.2 and 19.7 meters, respectively); 12 kw. "Marseillaise" at start and close of program. "Hello, hello, ici Paris, Radio-Coloniale, 103 Rue de Grenelle."
- GSA to GSG—DAVENTRY, ENGLAND (6,050, 9,510, 9,585, 11,750, 11,865, 15,140 and 17,770 megacycles, respectively; 49.6, 31.6,

31.3, 25.5, 25.3, 19.8 and 16.9 meters, respectively); 15 to 20 kw. Announces "London calling." Plays "God Save the King," and gives Big Ben chimes on the hour.

HVJ—VATICAN CITY (5,970 and 15,120 megacycles; 50.3 and 19.8 meters, respectively); 10 kw. Announces "Pronto, pronto, Radio Vaticano."

I2RO—ROME, ITALY (6,220 and 11,810 megacycles; 48.2 and 25.4 meters, respectively); 9 kw. Lady announcer, "Radio Roma" or "Radio Roma Napoli."

OXY—SKAMLEBACK, DENMARK (6,000 and 9,520 megacycles; 49.2 and 31.5 meters, respectively); 1/2 kw. Broadcasts midnight chimes at 6 P.M. (E.S.T.).

SRI—POZNAN, POLAND (9,490 and 9,570 megacycles; 31.6 and 31.4 meters, respectively). Announces "Hello, hello, Polski Radjo-Poznan."

T14NRH—HEREDIA, COSTA RICA (9,670 and 15,075 megacycles; 31 and 19.9 meters, respectively). Single call or tic-toc between selections.

VK2ME—AUSTRALIA (9,590 megacycles; 31.3 meters); 12 kw. Laughing notes of the Kookaburra bird open and close program.

To convert above megacycle figures to kilocycles, change the decimal point to a comma. Example—6.060 megacycles = 6,060 kc.

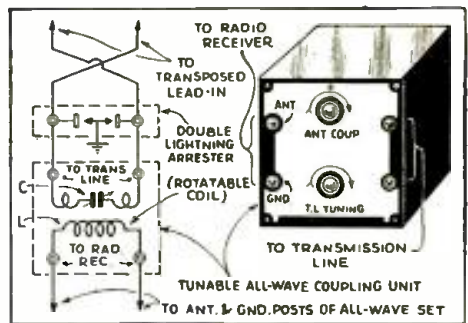

Fig. 3B  
Tuned coupling insures high efficiency.

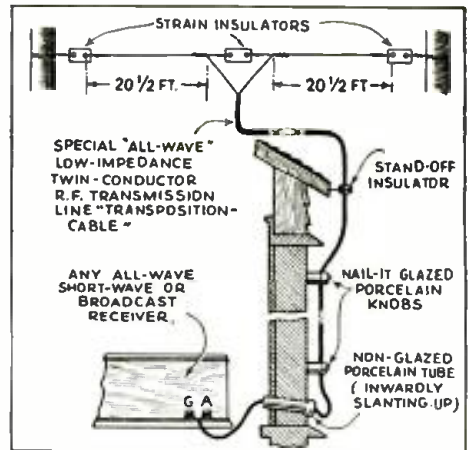

Fig. 4  
A "transposition-cable" antenna.

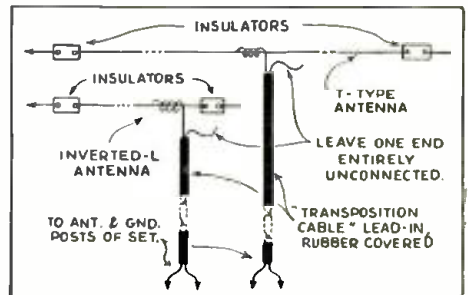

Fig. 5  
Useful applications of "transposition-cable."

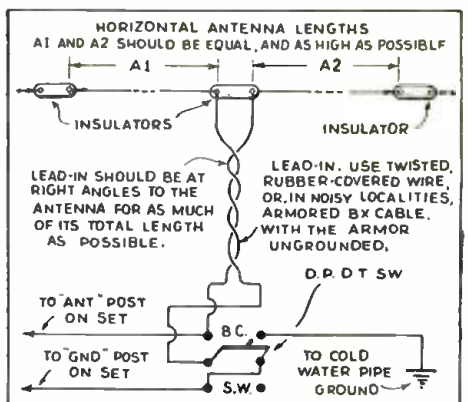
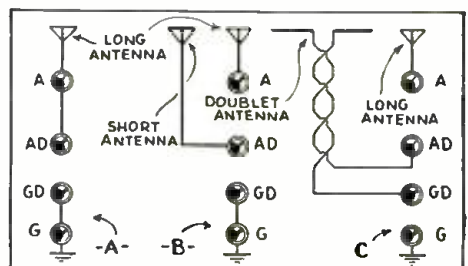

Fig. 6  
A "T" or "doublet" selector switch.



### A High-Quality Doublet Antenna System

(3) Doublet With Transposed Lead-in and Tuned or Untuned Impedance-Matching Transformer. Use of a "transposed" lead-in permits good reception to be obtained in localities where the noise-level is quite high, as previously mentioned. (Note that, inasmuch as we are using every artifice to entirely remove the antenna system from all sources of man-made interference, the use of an electric light, telephone or telegraph line, or an "indoor antenna" unit that utilizes the ground lead for an aerial, is taboo; such makeshifts or substitutes will only increase the noise-to-signal ratio.) However, the trick is to keep the two down-leads as far apart as possible, within reasonable limits, if the shortest wavelengths are not to be too greatly attenuated. This figure of "reasonable limits" is conveniently obtained by using "transposition" (Continued on page 107)

The important points to keep in mind are: secure (a) height; (b) insulation, and; (3) freedom from surrounding objects.

Note that the use of indoor antennas of every type must be discouraged by the radio man who wants his customer to be satisfied with his all-wave set. Do not forget for a moment that, as stated in Part I, the satisfactory reception of signals below 200 meters is almost entirely a matter of securing the highest possible signal-to-noise ratio. This condition cannot begin to be satisfied when the pick-up portion of the antenna is placed indoors where it can respond to every house-wiring radiation of man-made interference generated both within and outside the house.

The antenna shown in Fig. 2, for practically all locations in the United States, should be run north-east by south-west, with the lead-in taken from the north-east end, to secure best reception of overseas stations.

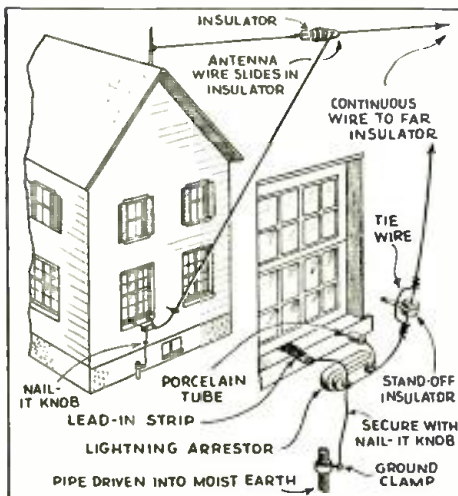

Fig. 2  
A good inverted-L antenna.

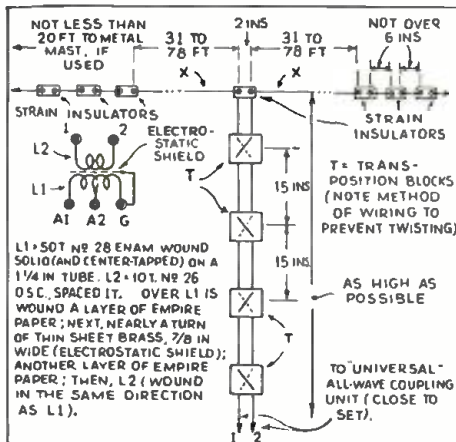
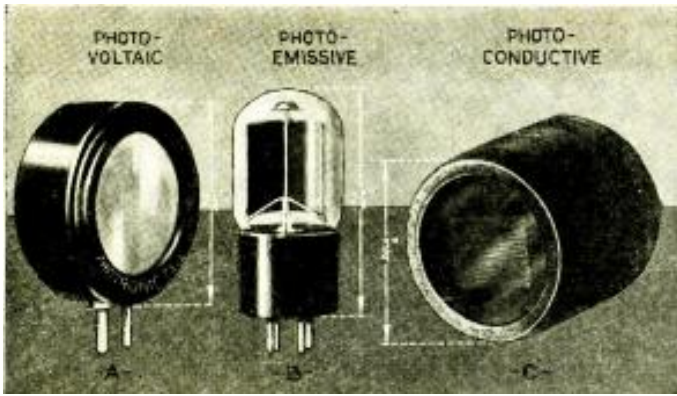

Fig. 3A  
A good dipole antenna system.

Fig. 7, right  
The wavelength range switch of a modern set selects the most suitable antenna.



A, copper-oxide, B, caesium or other types, C, selenium.

# THE P. E. CELL

The application of photoelectric cells in the radio and electronic field are becoming more common every day. However, a great many Service Men are not completely familiar with this subject, particularly concerning the characteristics of each type and what they are adapted for.

A. J. McMASTER

THE various forms of light-sensitive cells are classified as follows: (1) photo-emissive, (2) photo-conductive, (3) photo-voltaic. Each type is analyzed as to color sensitivity, static response to variations in light intensity, and dynamic response at audio frequencies. Curves are shown illustrating the operating characteristics. A brief comparison of the merits of each type for different uses forms the conclusion of this article.

Although some of the electrical effects of light on certain substances have been known for nearly 100 years, it is only within the past decade that substantial and significant progress in the engineering application of light-sensitive devices has taken place. In order that we may find a proper place for photoelectricity in the modern scheme of engineering practice, let us consider for a moment some of the many forms of engineering in which the primary objective is the transformation of one form of energy to another. Thus, we have various forms of so called electrical generators in which mechanical energy is converted to electrical energy. This process is readily reversible in transforming electrical to mechanical energy by means of motors, solenoids, etc. Again, either mechanical or electrical energy may be changed to heat. Such processes are in some cases also

reversible as evidenced by friction, electrical heating, the turbine, and thermoelectricity. Chemical energy may serve as a source of electrical power, and when we charge our automobile battery we again reverse the transformation process. One could name other examples of this universal effort to change one form of available energy to another, but sufficient mention has been made to establish the desirability of seeking engineering means for making all forms of energy interchangeable. Let it suffice to call attention to the breadth of engineering and industry based fundamentally on the conversion of acoustical energy to electrical energy and vice versa.

But we have not as yet considered one of the most abundant forms of energy, namely, that of light. Abundant not only in nature, it is of course produced artificially on a tremendous scale. The utilization of solar energy goes on everywhere about us, but not in a direct and readily controllable manner. It is not the purpose of this paper to suggest a photoelectric method for the direct transformation of the sun's energy. This process, though possible is yet too inefficient to be of the least economic value. However, we shall direct our attention briefly to the devices available for the utilization of light energy for measurement and control purposes.

## Photoelectric Cells

Photoelectricity has been defined as any electrical effect produced by the action of light. Three fundamental types of light-sensitive phenomena will be considered briefly. The *photo-emissive* effect, though not the oldest, is perhaps (Continued on page 120)

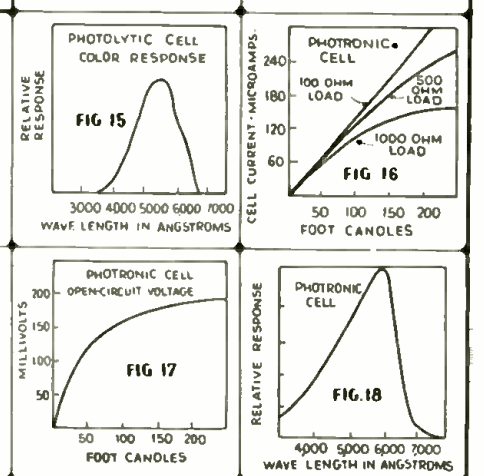
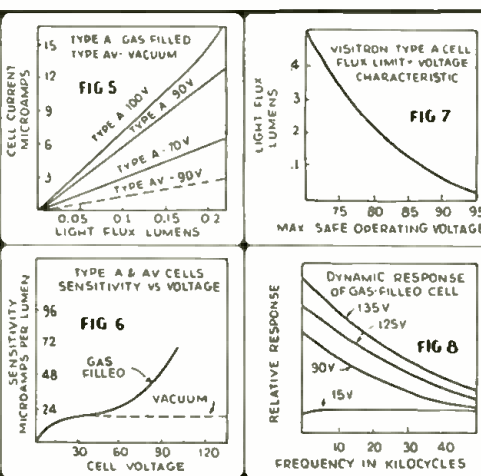
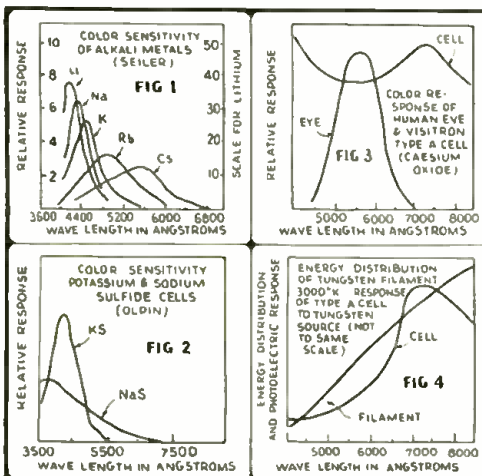
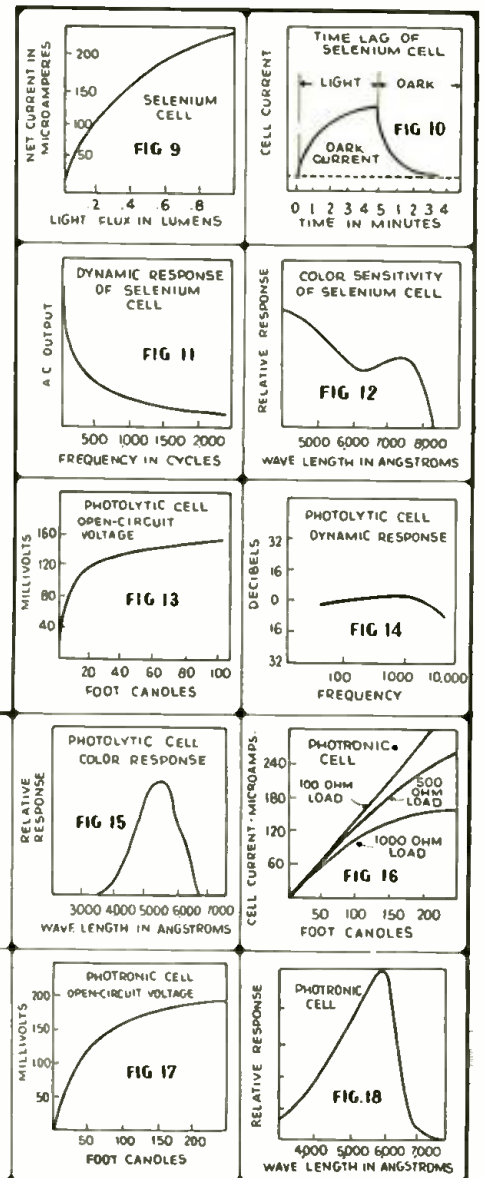

The above curves show the various characteristics of the 3 most used types of P.E. cells; namely, photo-voltaic, photo-emissive, and photo-conductive types. The first is popularly referred to as the copper-oxide cell, the second as the caesium or other gas-filled tube types, and the last is typified by the older selenium cell.



# A LONG-WAVE TUNER

There are few receivers that are able to receive broadcasts from European stations. This is due, primarily, to the wavelength these stations use. The author describes a "tuner" which permits the reception of these foreign programs on wavelengths between 500 and 2,000 meters.

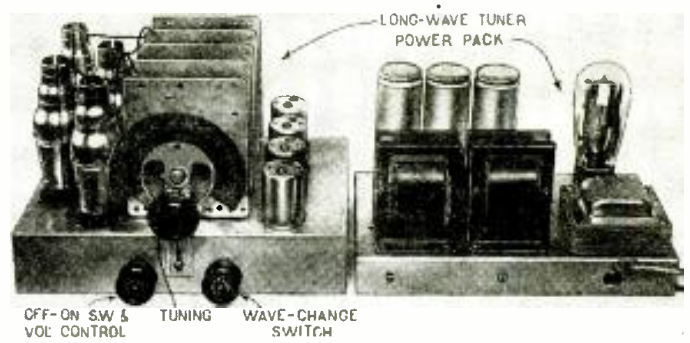

F. R. HARRIS

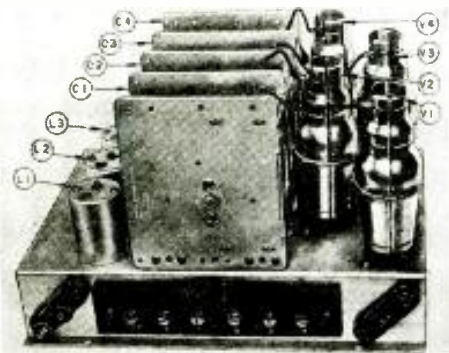

Fig. A  
Location of tubes, coils, etc.

SHORT-WAVE reception has, recently, become quite the fad and the general public has become "short-wave conscious." It is not, however, so generally realized that there is a considerable band of frequencies below the regular broadcast band (higher wavelengths) in which there is much worth hearing. Marine police, aircraft dispatching and weather reports are all carried on in phone within this band. In addition to this, for those who can read code, there are innumerable government and other services. By International agreement, also, regular broadcasting is carried on within the band from 160 kc. to 230 kc. (1,875 meters to 1,340 meters), stations within this range being located all over Europe, some using considerable power.

Luxembourg, for instance, on 1,304 meters (230 kc.), is rated at 200 kw., and has been consistently heard in the United States. For those who have tired of the, nowadays, commonplace reception of world-wide short-wave programs here is a new mark to shoot at, and a mark which is much more likely to result in the reception of really enjoyable programs since long-wave transmission is not affected by daylight or dark conditions to the extent with which it is found on the shorter waves; long-

wave fading is almost unknown and man-made static is almost non-existent, only electrical storms causing any considerable interference (mostly in the summer).

Another feature which will make long-wave reception increasingly reliable and interesting to American radio fans is the rush to greater and greater power on the part of European stations. With these points in mind the "long-wave tuner" illustrated and described in this article was designed and built.

## Design

In laying out the set several points were given especial consideration. The set must, of course, be sensitive in order to be of any use at all. It must be selective in order to cut through the maze of local code and other service stations and bring in the much more distant phone station that we want. It must be simple to construct and to put into operation if the average home builder is to have any chance at all of building it, and it must be reasonable in price.

After much consideration the choice finally fell on a straight tuned radio frequency set of 4 stages having no audio frequency amplification, and depending on a separate power supply.

(Continued on page 116)

### Possible European Stations on L.W.

Station Location	Station Meters	Power in Kw.	Hours Diff <sup>a</sup>
Moscow (U.S.S.R.)	1,724	500	7
Paris (France)	1,648	75	5
Königswusterhausen (Germany)	1,571	60	6
Minsk (U.S.S.R.)	1,442	100	7
Warsaw (Poland)	1,345	120	6
Luxembourg	1,304	150	5
Kalundborg (Denmark)	1,261	75	6
Leningrad (U.S.S.R.)	1,239	100	7
Oslo (Norway)	1,181	60	5

<sup>a</sup>Time difference figured from Eastern Standard Time.

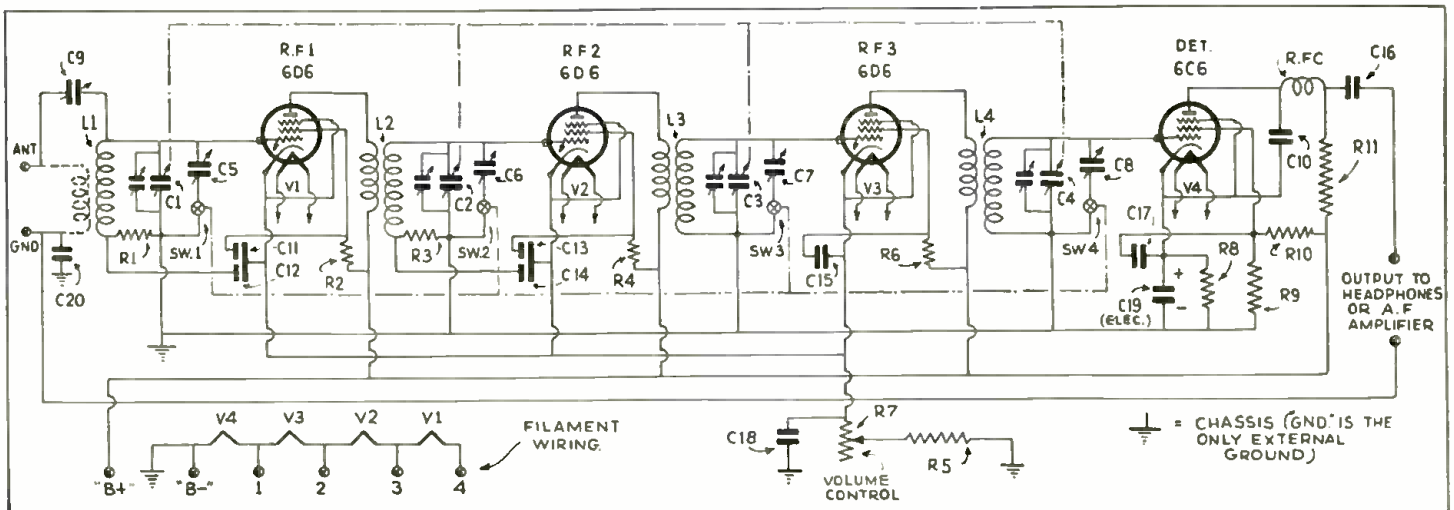

Fig. 1  
Circuit of long-wave tuner. The A.F. amplifier of the regular receiver is employed for loudspeaker reception.

# UPLIFTING THE SERVICING PROFESSION

In this concluding chapter, the author suggests numerous ways for augmenting the Service Man's income. Some very pertinent advice concerning the technician's obligations to the customer should be thoroughly digested and considered by readers.

F. E. COLT

PART III

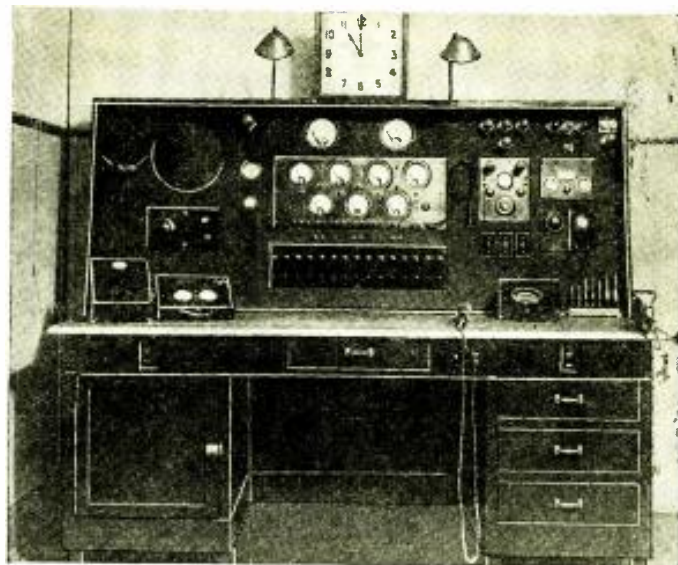

Fig. A. Third-prize winner, Nat'l Union Radio Corp's. Best Service Bench contest, Lyon Radio Service, Syracuse, N. Y.

IN THE June and July issues of RADIO-CRAFT the writer discussed ways and means of setting up a profitable radio service shop. In this, Part III installment, we go into details, and now take up the subject of the guarantee tag. The guarantee tag is only an acknowledgement that you are ready to make your work right in case of defective parts.

If you make a real effort to do your work right and are careful to do it well and use only parts from well-established old-line manufacturers whose wares have proven good, you will not have to worry about guarantees. Of course there may be exceptions to this rule, as in all rules, but if you do have a come-back, make the necessary corrections and do it with the biggest smile that you can possibly muster. This will win you more customers than you now realize, and helps develop better service technique instead of slipshod habits.

## A Profitable "DX" Trip

This reminds me of a trip I made one time. Although it cost me some lost time it, in turn, brought me about 25 new customers. A man came into my shop with a Crosley battery set packed in a dust-covered box—I soon found out that he lived 20 miles beyond a neighboring town which was 15 miles from my shop. The set needed new tubes, new batteries and a good cleaning and balancing. I reconditioned the receiver, set it all up, tried it out, and it worked splendidly.

He came in and got the set and I did not hear from him until a week later when he brought the set in again and asked me to try it out saying he could not get a thing over it! I hooked up the set and it worked again excellently, so we came to the conclusion that he must have had it connected wrong. This time I connected it all up, marked the wires, made him a pictorial diagram and schooled him about getting the polarity right on the "A" battery, which was the only thing he did not bring in with him. He said that on his way home this time he would get his "A" battery which he had left in the neighboring town to get recharged and then he thought he would be able to receive the opening game of the World Series the following day.

Imagine my surprise when I got a long distance call that evening from him out on his ranch 35 miles from my shop, telling me that he couldn't get any response! He was disappointed and half-way angry. The first thing he asked was if I guaranteed my work and would I make it right. After a brief conversation to find out whether he had got it hooked up all right, I told him that I would come out on one condition—that if the trouble was due to any error on my part I would not charge him for the trip but if it was a case of a bad "A" battery or a wrong hook-up, I would charge him for the trip.

This was agreeable so I drove out.

When I arrived I just looked over all of the connections. Everything was O.K. I then started to work by testing the "A" battery. This battery showed shorted cells and as soon as a load was connected it went flat. He watched me and saw the test himself so he drove to the nearby town and bought a new battery. When he got back we connected it up. How the stations did roll in from all over the U. S. Did he pay me? I'll say he did—not only mileage plus time, but he slipped me \$2.00 more. Was he happy—and was I?

A week later I received a call from the only radio dealer of this town where the man bought the battery, saying that he had a few sets he wanted me to check up. I went up and as a result had 2 day's work of about 30 sets to clean, test and repair.

Did this guarantee business pay?  
(Continued on page 101)

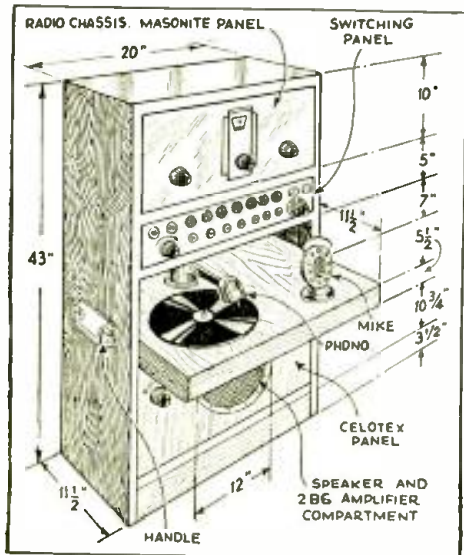

Fig. 1. Complete public address panel, for testing, and store ballyhoo.

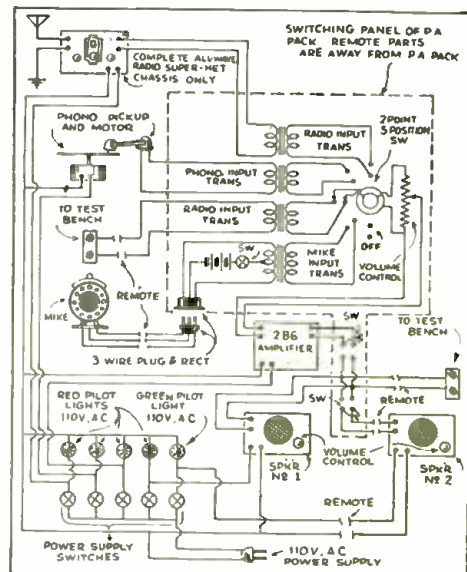

Fig. 2. Connections of various equipment employed in public address rack.

# CONVERTING OLD RECEIVERS

There are, unquestionably, numerous receivers, purchased years ago, that still function satisfactorily, but which can be made more efficient and brought up-to-date by a few changes and alterations. It is the purpose of this and subsequent articles, to inform Service Men and other interested parties regarding these modifications. Also, "conversion" data will be given for revamping old electric sets to those of modern "dry-cell tube" type—those who live in rural section, where electric light line power is unavailable, will be especially interested in this data.

## IMPROVED DETECTION AND A.V.C. FOR APEX MODEL 7

THIS circuit change in Apex model 7 may be used by the Service Man to make an "extra dollar" or as an original by the set builder and experimenter, due to its high efficiency and stability.

In making the change the heater circuits remain as is, except winding "H" the center-tap of which is grounded. The 27 tube socket is replaced by a 6 prong socket for the 55 tube. The old 24 A.V.C. socket is used for the 56 tube, which may be coupled to the 47 as shown in Fig. 1, or transformer-coupled, as preferred. The grid and plate connections are the same on the R.F., first-detector and I.F. stages, only grid-return and cathode leads being changed.

A 0.5-meg. volume control with built-on switch may be used. This eliminates the need for the A.C. switch on the side of the cabinet.

Alignment: R.F., 1,400 and 600 kc.; I.F., 175 kc. The revised circuit is shown in Fig. 1.

IRBY WHITE

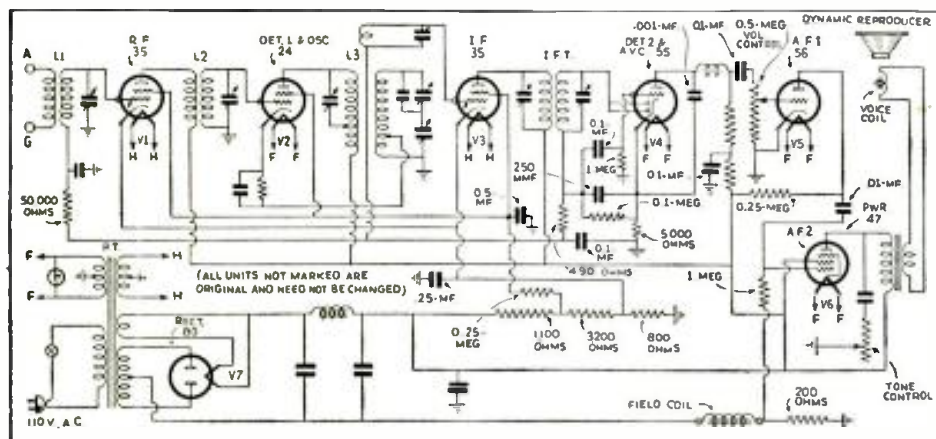

Fig. 1

APEX MODEL 7. This is a revised circuit incorporating improved detection and A.V.C. The detector tube (a 27) is replaced by a 55 tube and appropriate socket, and the old 24 tube, by a 56. All necessary values are indicated.

## ADDING A.V.C. TO A TEMPLE 8-91

NO DOUBT many Service Men throughout the country have experimented from time to time with the problem of a workable A.V.C. modernization of old-type radio receivers. The very provocative possibilities of the duo-diode-triodes finally snared the writer into such a venture, and, while the results achieved were excellent, the resultant headache was a wow!

The set selected for the experiment was a Temple 8-91—one of the models using a tuned antenna coil and coupling the 24 first R.F. to the 27 second R.F. via a .002-mf. mica condenser, with appropriate chokes in the plate and grid circuits.

The circuit diagram, Fig. 2, shows in detail the new connections. The 4 gang tuning condenser is so constructed as to lend itself readily to insulation from the chassis which, of course, is absolutely necessary. The blocking condensers C 1, 3, 4 and 5, are essential, but are not at all critical as to capacity. Condenser C7 is somewhat critical, and should in no case be less than .5-mf. Condenser C17 proved to be the real stumbling block in the job. Every experimental change in R4 called for a corresponding change in this particular capacity and the overall sensitivity of the entire circuit centers around it. Those who care to try it will find that a variable condenser at this point will enable them to bring the R.F. stages up to oscillation at any point on the dial.

Exhaustive experimentation showed a considerably better overall efficiency with the 2A6 tube used as a half-wave detector, self-biased and, contrary to a great deal which the writer has read (Continued on page 112)

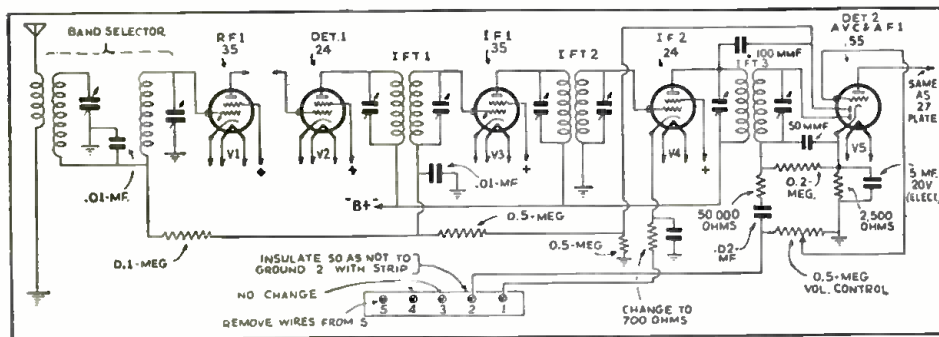

Fig. 2

TEMPLE 8-91. The new circuit shown above is a considerable improvement—accomplished by employing a 2A6 as a half-wave detector, self-biased, and an A.V.C. arrangement that was derived only after considerable experimentation.

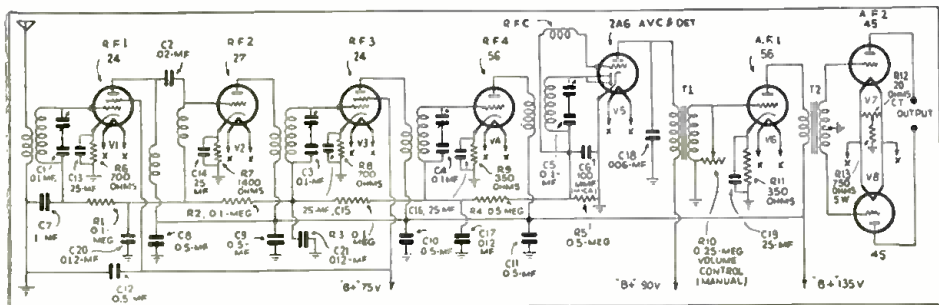

Fig. 3

WESTINGHOUSE WR-7, RCA 80, 82, etc. A combined second-detector and A.V.C. stage is the improvement shown in this circuit. This change will improve the set considerably, and incidentally bring it up-to-date with later models.

# A SELF-POWERED 2 TUBE SHORT-WAVE CONVERTER

Short-wave converters offer the Service Man a splendid opportunity for making extra money. This simple and inexpensive unit will readily sell itself on every demonstration.

ELLIS COHEN\*

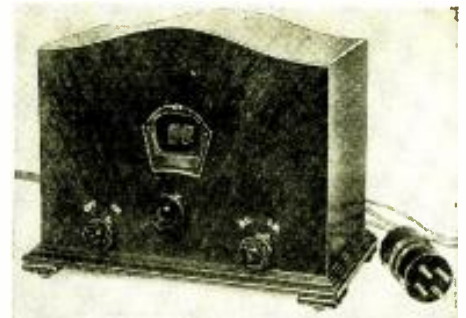

**A**LTHOUGH short waves offer almost unlimited reception possibilities and is becoming increasingly popular every day, it is not available to most radio set

Insligne Corp. of America

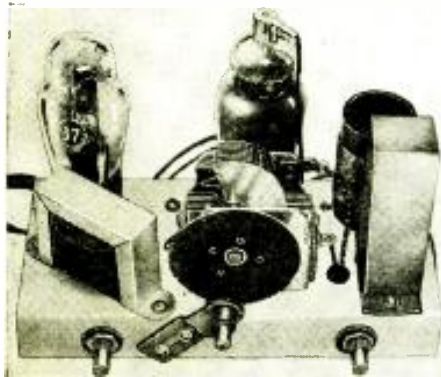

Fig. A  
Chassis appearance and layout.

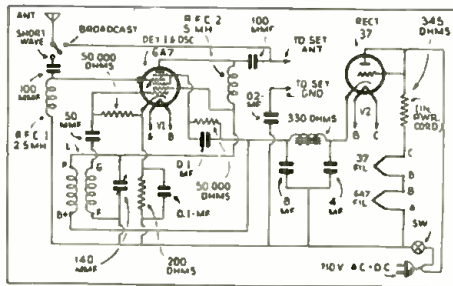

Fig. 1  
Diagram of 2 tube S-W. converter.

listeners. Perhaps this may be due to a mistaken idea that a complete new receiver is necessary if both broadcast and short waves are desired; but more likely it is probably because most local technicians fail to keep their customers acquainted with new advances and progress made in radio. Where this obligation to the customer is not fulfilled, a

most satisfactory and quick sale, and therefore a means for augmenting his income, is being overlooked by the Service Man.

The sale of a short-wave converter can be easily expedited, when the features of the reception possibilities are pointed out to the prospective customer. They should easily interest the customer, and are as follows:

- (1) Police calls;
- (2) Amateur radiophone—the gossip of the “hams”;
- (3) Broadcasting;
- (4) Airplane radiophone conversation;
- (5) Extreme “distance”—an inherent characteristic of short waves.

## Principles Underlying Short-Wave Converters

Since the ordinary broadcast receiver  
(Continued on page 113)

# A VERSATILE OSCILLATOR

An oscillator such as described below is a most valuable asset to the Service Man. It is entirely self-powered, operates from either A.C. or D.C., and generates A.F., I.F. and R.F.

S. S. EGERT\*  
S. BAGNO

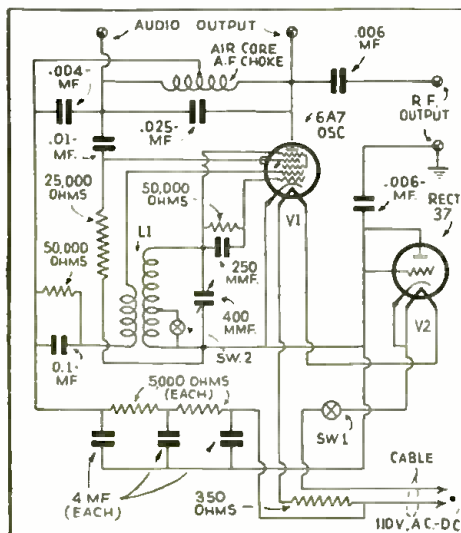

Fig. 1  
Oscillator output = 1,000 cy. (A.F.), 105-500 kc. (I.F.), and 500-3,000 kc. (R.F.).

**W**ITHIN the past two years the standards for radio receivers of simple design have become increasingly complicated. With the introduction of the multi-grid and double-purpose tubes the average Service Man, when confronted with the general service problem must necessarily be the equivalent of a good radio engineer. In other words, the old hit-or-miss method of cut and try is slowly evaporating into a myth, since with some of our modern receivers we can “try, try again” for the next year without getting anywhere. Also, with word coming from the manufacturers that receivers now being designed for next year’s models will be even more complicated than those which have heretofore been sold, the prospect of doing a good service job without adequate

service equipment becomes almost hopeless.

One of the most essential instruments necessary to check a really modern radio receiver is a signal generator, or service oscillator as it is more popularly known. There are many characteristics which can be included to make a good oscillator. (1) The unit should be universal in regard to its power supply; (2) it should be stable in regard to frequency; (3) it should have adequate modulation, and, (4) it should be accurate in regard to frequency readings. Also of prime importance, the instrument should be capable of covering a wide band spread—since at present there are no such things as standard intermediate frequencies; also, most of next year’s sets will be designed to operate either over a greater wavelength range than at all-waves, or at least part  
(Continued on page 114)

\*Wireless Egert Engineering, Inc.

# A COMPLETE SET TESTER

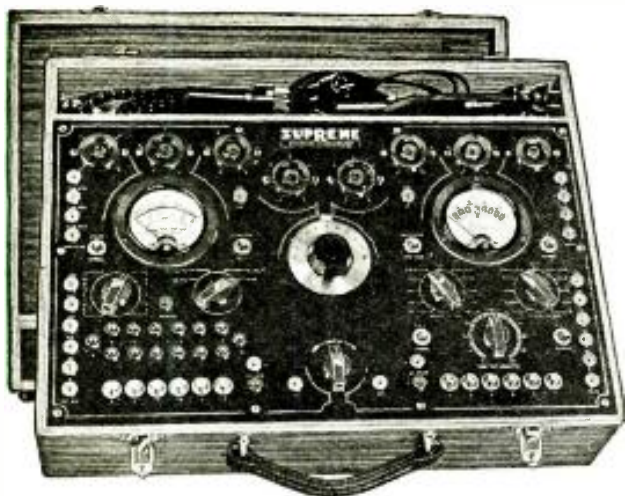

Servicing equipment, if it is to aid the Service Man in solving all troubles, must be as complete as possible. The author describes in this article equipment that will not only reflect credit on the technician who owns it, but will permit him to make any desired test or measurement.

W. H. ASHCROFT\*

THE most "professional" portable set-testing equipment is that which includes, in one handy unit, all of the testing facilities which are required for either preliminary or complete and detailed tests and adjustments of any radio receiver. Such a tester should include the following units: (1) an efficient English-reading tube tester; (2) an accurately-calibrated service oscillator, and; (3) a complete, "straight-forward" analyzer with, (a) an ohmmeter, and (b) capacity-measuring facilities. It is recognized, of course,

that all of these testing and adjusting facilities are not required on most service calls, but there are times when they are convenient for use in homes which are located at a considerable distance from the Service Man's shop or laboratory.

### A New Test Instrument

The latest development in test equipment for the radio man, illustrated in figure has been designed to meet these requirements. Also, it has been designed with a view to having "eye value," for, after all, if a technician is going to invest any considerable sum

in a high-grade tool, why should he not expect that its worth be made apparent, within certain limits, to the layman by the way in which its appearance is "dressed up"?

Two meters are included in the tester. One is provided with an English-reading scale, marked "good—bad" for the tube tester.

The other is used for the analyzer, ohmmeter, and for the capacity-measuring functions. It has the following ranges: potential, 0/5/25/125/250/500/1,250 V., A.C. and D.C.; current, 0/5/25/125/250/500 ma., and 1.25 A., D.C.; re-

(Continued on page 118)

\*Development Engineer, Supreme Instruments Corp.

# AN IMPROVED MAGNETIC SPEAKER

A new magnetic speaker has made its appearance which will do much toward redeeming the "one-time" popularity of this type of reproducer. The construction of this unit is unique, yet so efficient in design that remarkable sensitivity and faithful reproduction are attained. It is ideal for portables and dry-cell tube receivers.

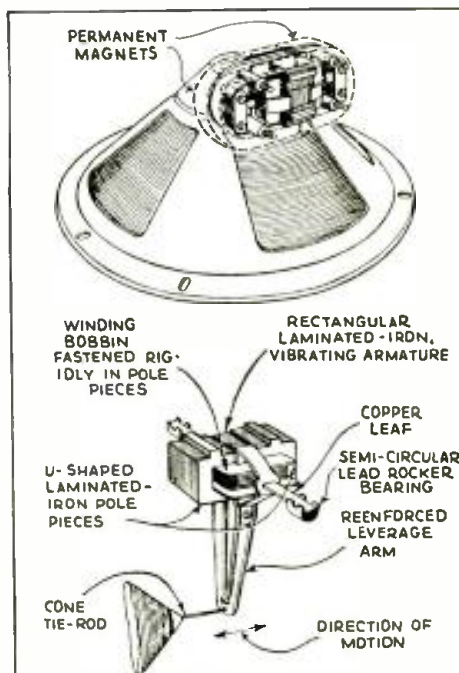
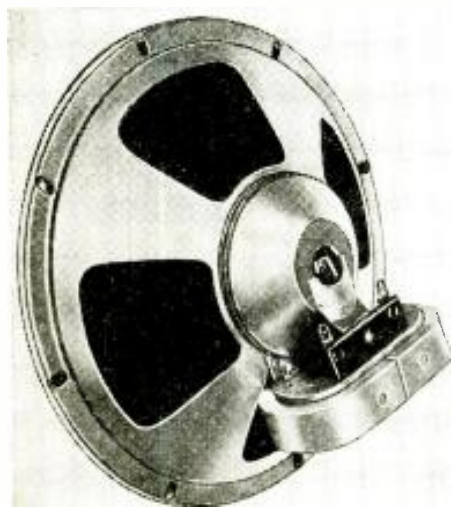

Fig. 1  
Illustrating, in detail, construction of a new improved magnetic speaker.

Fig. A, extreme left  
Complete appearance of new speaker.

(Photo courtesy, Utah Radio Products Co.)



MAGNETIC speakers still serve to fill an important gap in radio receiver design, and construction. As a matter of fact, present auto-radio receivers would have had a unit of this type included in their construction had it not been that up until this present time an efficient magnetic type of speaker unit was difficult to obtain. As it is, we still find them in use in farm or rural receivers, portable sets, and in practically all forms of dry-cell tube types of radio receivers.

The important points in favor of magnetic speaker use enable it to fill a void that is otherwise impossible with the dynamic type. It should be remembered that a speaker of this construc-

(Continued on page 118)

# A DELUXE 4 TUBE SHORT-WAVE CONVERTER

The features that distinguish this converter from others include not only its careful design and construction, but additional high gain and selectivity; also, an unusual and most efficient means for band changing permits complete short-wave reception. The unit described here is for 110 V. A.C. operation.

S. MILLER\*



Fig. A  
External appearance of converter.

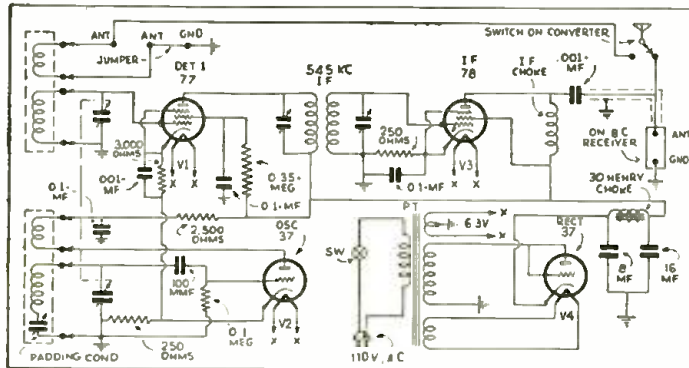

Fig. 1  
Schematic wiring diagram of 4 tube converter.

THE question often arises as to whether or not a combination of high-grade converter and a fairly good broadcast set can perform as efficiently as a receiver designed specifically for short-wave reception. The writer states, emphatically, yes!

A correctly-designed converter, coupled to an average broadcast receiver may be more sensitive than a short-wave receiver because the use of an efficient converter automatically changes an ordinary T.R.F. broadcast receiver into a super-het., or it changes a broadcast "super" into a double-shift short-wave superheterodyne with three detectors and two different intermediate frequencies.

Actual performance tests have conclusively proven that a real, high-class converter will increase the overall sensi-

\* Chief Engineer, Postal Radio Corp.  
(Continued on page 110)



Fig. A  
Everything necessary for P.A. work.

# A MOBILE P. A. SYSTEM

This public address outfit is a completely self-contained, compact system. A 6 V. storage battery supplies both "A" and "B" power, and the amplifier has an output of 20 W. A 2 speed phonograph motor permits record reproduction, besides "mike" use.

W. F. MARSH\*

THE public address market has been offered from time to time, a large variety of amplifier units intended for mobile use. While many of these outfits proved effective and fulfilled certain essential mobile requirements, few of them really represented a functional completeness.

### True Compactness and Completeness

Figure A demonstrates at a glance the compactness and completeness of a new mobile unit designed to overcome the faults of previous types. The possible applications of this sound system are numerous.

All of the necessary equipment (with the exception of speakers and microphone) is completely contained in a

\* Chief Engineer, Allied Radio Corp.

single steel cabinet with a baked crystalline finish, measuring only 11 1/4 x 14 x 16 in., and weighing only 65 lbs. Contained in this cabinet are a powerful, high-quality 6 V. class B amplifier of the latest design having an output in excess of 20 W., an input control panel, and a 2 speed, 6 V. phonograph motor with weighted turntable

Fig. 1  
Wiring diagram of 20 W. amplifier. A 6 V. motor-generator supplies high-voltage "B," and is operated by a relay.

and pickup. Provision is made on the side of the case for plugging in speakers and 6 V. supply leads. A microphone input socket is placed conveniently on

(Continued on page 110)

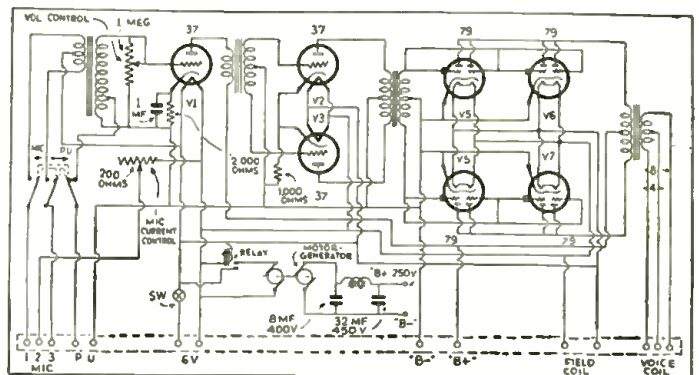

# THE ANALYSIS OF RADIO RECEIVER SYMPTOMS

## OPERATING NOTES

### WHAT THIS DEPARTMENT IS FOR

It is conducted especially for the professional Service Man. In it will be found the most unusual troubles encountered in radio service work, written in a practical manner, by Service Men for you.

Have you, as a professional man, encountered any unusual or interesting Service Kinks that may help your fellow workers? If so, let us have them. They will be paid for, upon publication, at regular rates.

### CANADIAN "NOTES"

THE following are a few of the more unusual service problems encountered by me in the past month or so.

#### ATWATER KENT No. 82

ONE complaint on this model was "set dead." We checked all voltages carefully only to find everything O. K. We then removed the 24 A.V.C. tube which is located at the rear of the chassis as shown in Fig. 1A. The set then worked perfectly. We immediately tried several new tubes but with the same result. We looked over the schematic, which is shown in Fig. 2A, and found a bleeder resistor, connected from one side of the volume control to ground, which measured 700 ohms. We found that by replacing this resistor with a 1,000 ohm unit the trouble was completely remedied and the set would perform with the original tube. The owner of another set of the same model complained of "motorboating" when the volume control was set at low-volume level. The trouble was traced to an open detector plate filter condenser—the .25-mf capacity shown at X in Fig. 1C. The remedy was replacement of the defective unit.

#### GENERAL ELECTRIC 125-J-12 TUBE SUPER

"MOTORBOATING" was the complaint in this set. As we approached a station, in tuning, the set would motorboat. A complete check with the schematic was made of voltages, etc., and everything checked perfectly. As a last resort we tried re-adjusting the set completely, but without any success. We finally hit upon the defect by cleaning the condenser gang contacts, whereupon the set again worked perfectly. However, this we found to be a very unusual case although well worth while bearing in mind as a probable reoccurrence of this trouble elsewhere.

#### DeFOREST CROSLY ARIA

A LOUD squealing as the set was first turned on, after being turned off for a short time, proved to be due to a gassy 45 power tube, replacement being the only cure.

#### NORTHERN ELECTRIC No. 101 ALL-WAVE RECEIVER

THE owner of this set complained of low volume. A check was made of the voltages. (It might be well to state that this model contains 5 I.F. transformers.) It was found that the voltages on the last I.F. tube were seemingly low. We checked over all condensers and resistors, etc., which we thought would cause this condition, and found all checked O.K. But wait, a happy thought—we open the last I.F. transformer and there we find another tubular condenser which proved to be leaking; by replacing this unit the trouble was eliminated.

#### PHILCO TRANSITONE 5 and 6

LOW volume was found to be due to a shorted 20 mf. cathode bypass in the 41 output tube circuit as shown in Fig. 2. This condenser is part of a block of 4 condensers and, due to cramped space in these models, the whole unit must be replaced.

#### NORTHERN ELECTRIC MINAKI MIDGET SET

NO PLATE voltage on the pentode output tube of this model is usually due to a shorted tubular-type plate bypass .1-mf. condenser (and not, as might at first be expected, to the bypass condenser block which is located directly beneath the condenser gang).

#### THE DeFOREST CROSLY 8 TUBE SUPER

DISTORTION" was the complaint and we traced the trouble to the output circuit which, as shown in Fig. 3, (Continued on page 110)

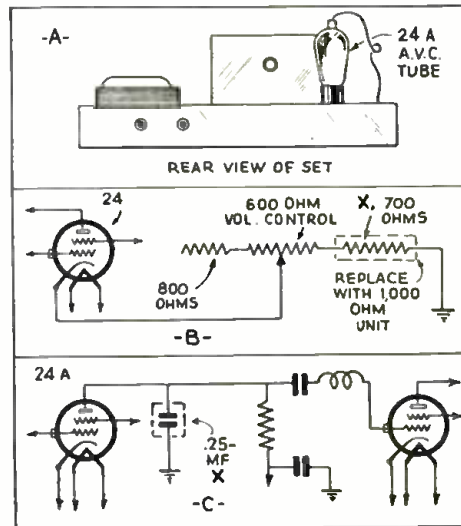

Fig. 1  
Several trouble makers in the A.K. model 82 set.

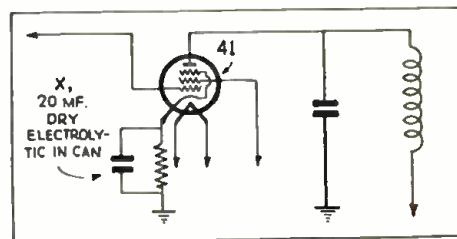

Fig. 2  
A defective condenser-block unit causes trouble.

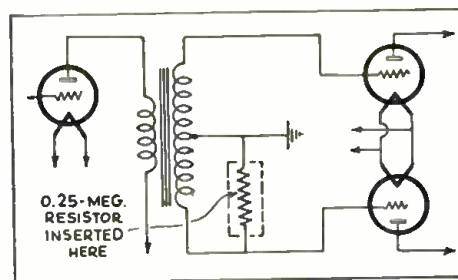

Fig. 3  
A "kink" saves buying a new audio transformer.

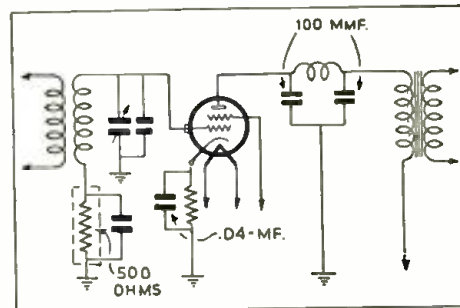
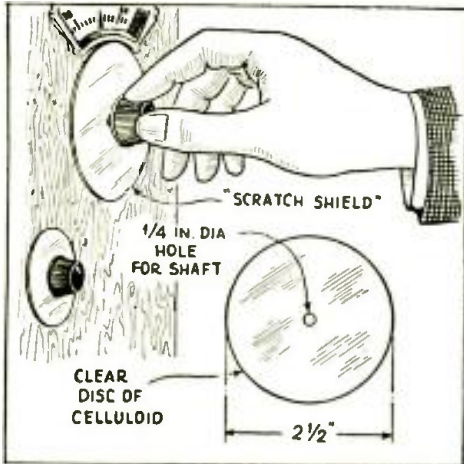
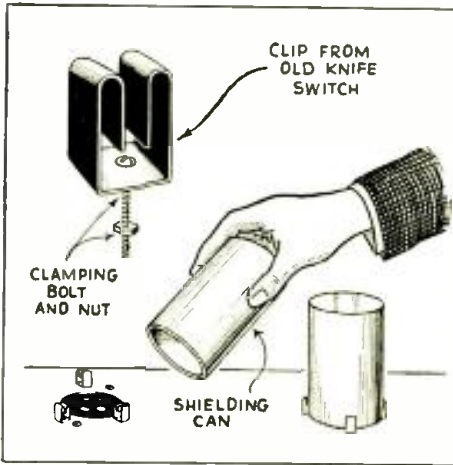

Fig. 4  
A hard-to-locate, defective resistor in a Majestic 230.

# SHORT-CUTS IN RADIO



IT IS difficult to grasp the controls of ultra-midget sets without marring the surface finish. The transparent scratch shield illustrated prevents this damage to the cabinet. —E. E. YOUNGKIN



THE use of knife-switch clips permits shield cans to be removed or replaced in a second. No longer there need to wonder how to make contact to "baking power can" shields. —CHARLES LATOUR, JR.

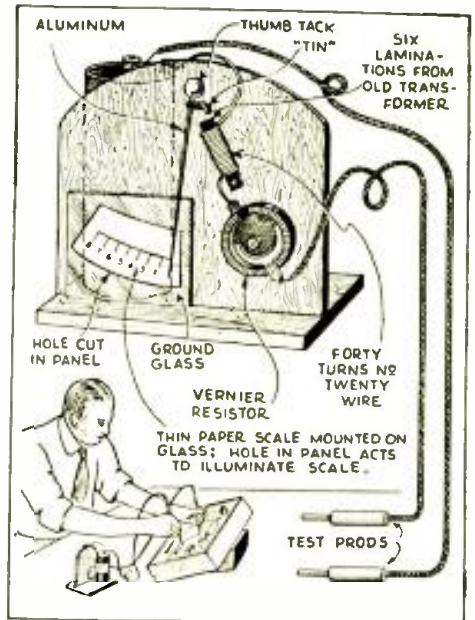

DESIRING to test the conductivity of some seemingly poor connections, and not wishing to invest in a millammeter at the moment, the above qualitative unit was made. It "reads" the resistance of a 1 in. length of wire. —MARK JONES

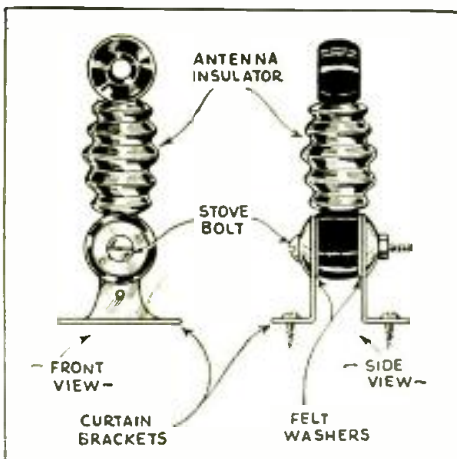

USE of the inexpensive standoff insulator illustrated above, which utilizes ordinary window shade brackets, will improve reception on the shorter wavelengths. —CHESTER McCLINTOCK

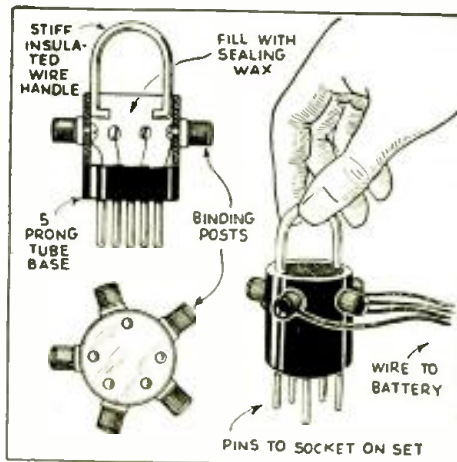

THE little service shop gadget shown above makes it convenient to disconnect all batteries from a radio set, or make battery-wiring changes, without disturbing other connections. —LYMAN O. GREENE

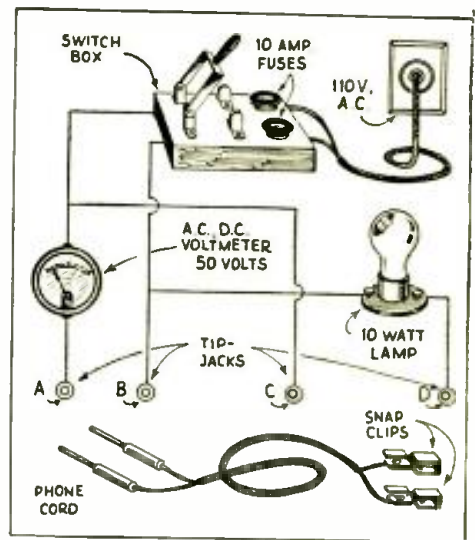

A USEFUL test unit. Tip-jacks A, B, test transformer primaries for counter E, M, F.; B, C, full current supply; C, D, condenser and continuity tests; A, C, battery-voltage tests. —CURTISS NEILSON

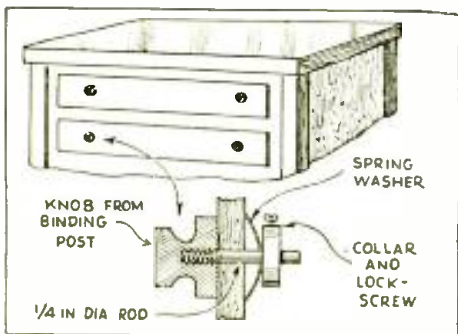

ABOVE, is shown the use of discarded midget-set knobs and "junk-boy" components as drawer handles. —JOSEPH LEEB

RIGHT, a method for securing additional connection points to an existing receiver. —FRANK L. KUTZENBERGER

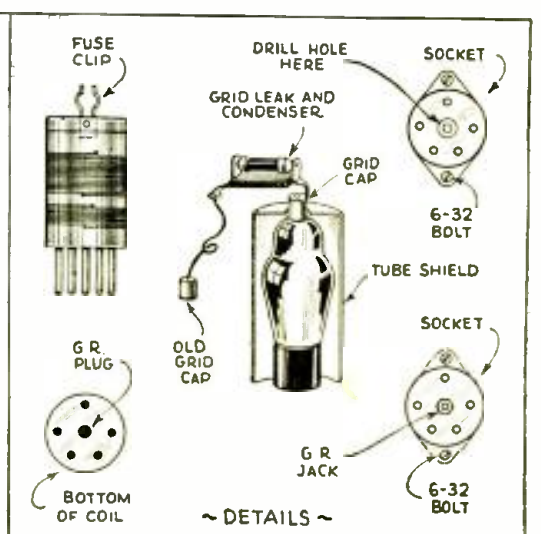
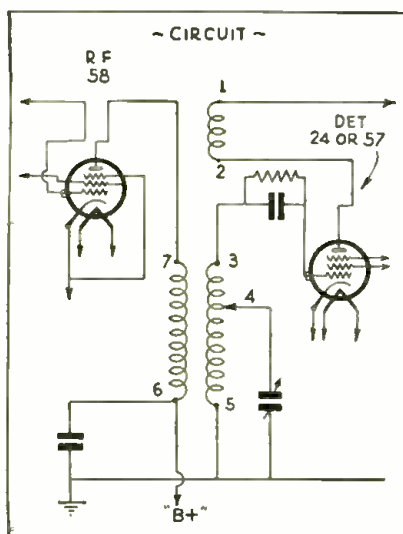



## A VARIABLE-NOTE CODE PRACTICE SET

Harold L. Kramer

USING most A.F. transformers in conjunction with a triode for use as an A.F. oscillator, a low-pitched note is obtained unless "A" and "B" are greatly reduced, in which case the volume is greatly reduced.

Connect up a Ford coil as shown in Fig. 1, use rated voltages, and your troubles are over. Any note may be obtained at loudspeaker volume. Any type of tube may be used.

Melt out the tar, remove primary and secondary, and discard former coil. Use the secondary sections in the manner shown; reverse the leads to one coil if the circuit does not oscillate. Arrange the core to slide within these two coils to vary the output frequency.

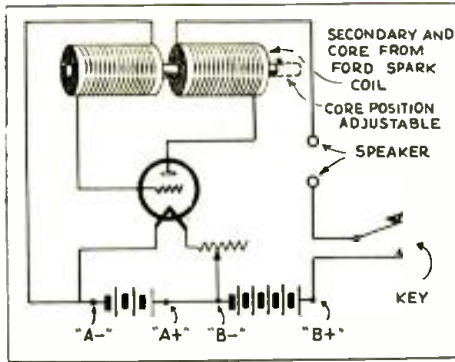

Fig. 1

A code practice set with variable tone.

## ADDING "GAS TEST" TO ANALYZERS

A. S. Cox

CONNECT a 1 meg., 1/2-W. resistor in the manner shown in Fig. 2, to add to analyzers a test for gassy tubes. Make certain that the pushbutton breaks one circuit before making the other.

Only one change in plate current should be noted. If the tube is gassy the plate current will change twice, first because of the gas content and consequent grid current, and second because of the usual change in grid bias.

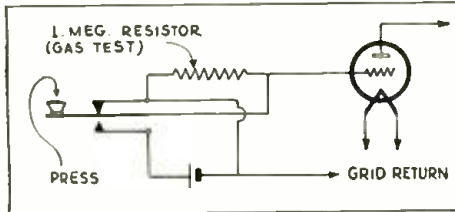

Fig. 2

Adding "gas test" to analyzers.

## TESTING REPRODUCERS IN THE SHOP

Allyn J. Warner

A GADGET has been made up by the writer for testing radio sets that come into the shop minus the reproducers.

Mount and identify tip-jacks on a panel in the manner shown in Fig. 3, connecting P, B+, and P, to a center-tapped choke coil; the writer used a unit salvaged from an old Radiola HI-A. This inductance takes the place of the reproducer input transformer primary.

The two condensers are used in series with a good, correctly-baffled magnetic reproducer.

The tapped resistor takes the place of the field winding.

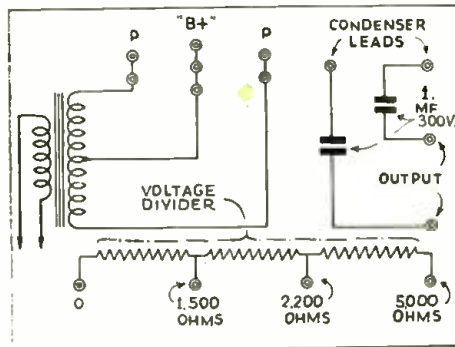

Fig. 3

A shop set-up for testing speakers.

**NOTICE:**  
Mr. Experimenter—what is your idea of time- or money-saving ideas? Most radio men have a great number of short-cuts that they employ in their daily work—short-cuts that speed work or save cash. RADIO-CRAFT will pay, upon publication, space rates for clever ideas in radio—and its allied fields. The items, which must be NEW, may include ideas in radio reception; photoelectricity; television; electronic music; radiodynamics; and public address.

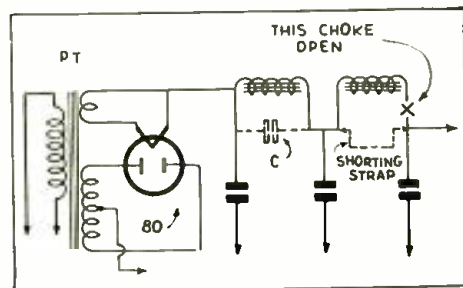

Fig. 6

Emergency operation of an A.K. 60.

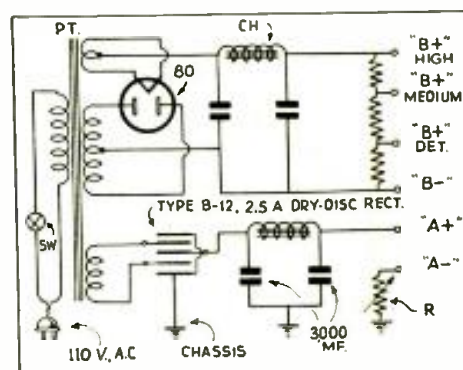

Fig. 7

The Dumont "A" and "B" eliminator.

## A "B" CUT-OUT RELAY FOR RURAL RADIO SHOPS

W. Rasmussen

MANY battery sets have defects such as leaky condenser blocks or other circuit components that cause current drain. This becomes a serious item to the Service Man in rural districts who must depend upon batteries for his high-voltage power supply. By revamping the relay from an old Philco or Bosch "A and B" eliminator and connecting it as shown in Fig. 4, the "B" batteries will be automatically disconnected when the "A" battery circuit is opened.

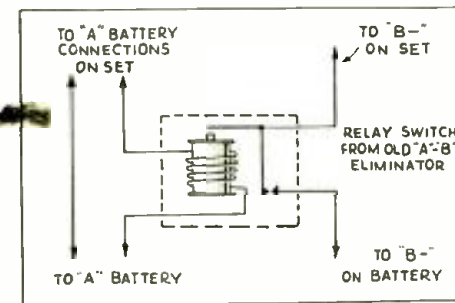

Fig. 4

A service-shop "B" battery cut-out.

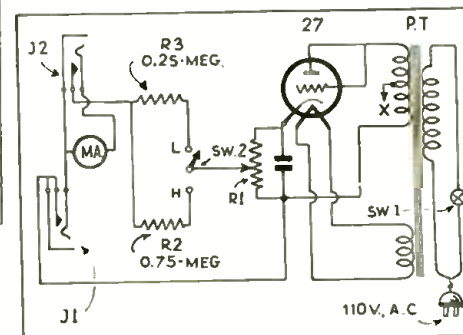

Fig. 8

A "megger"—range, 1 to 15 megohms.

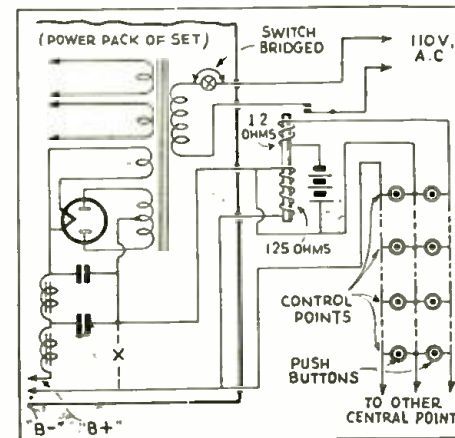

Fig. 5

Remote control of the radio set.

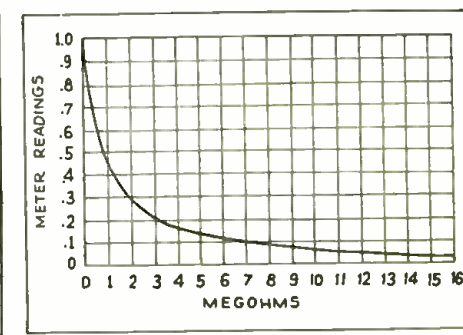

Fig. 9

A graph for the megohmmeter.

(Continued on page 114)

# RADIO-CRAFT'S INFORMATION BUREAU

## SPECIAL NOTICE

Those questions which are found to represent the greatest general interest will be published here, to the extent that space permits. (At least 5 weeks must elapse between the receipt of a question and the appearance of its answer here.) Mark such inquiries, "For Publication."

Replies, magazines, etc., cannot be sent C.O.D. Back issues of RADIO-CRAFT prior to December, 1932, are available at 50c per copy; except the following issues: 7/29, 2, 3, 4, 6, 9 and 11/30; 5, 8 and 9/31; and 10/32, which are out of print. Succeeding issues are still available at the regular price of 25c per copy.

Inquiries to be answered by mail MUST be accompanied by 25c (stamps) for each separate question; answers are subject to subsequent publication if considered of exceptional interest.

Furnish sufficient information (in reference to magazine articles, be sure to mention issue, page, title, author and figure numbers), and draw a careful diagram (on separate paper) when needed to explain your meaning; use only one side of the paper. List each question. Be SURE to sign your name AND address.

Enclose only a STAMPED and self-addressed envelope for names and addresses of manufacturers; or, in connection with correspondence concerning corrections to articles, as this information is gratis.

Individual designs can be furnished at an additional service charge. The fee may be secured by addressing the inquiry to the SPECIAL SERVICE department, and furnishing COMPLETE specifications of desired information and available data.

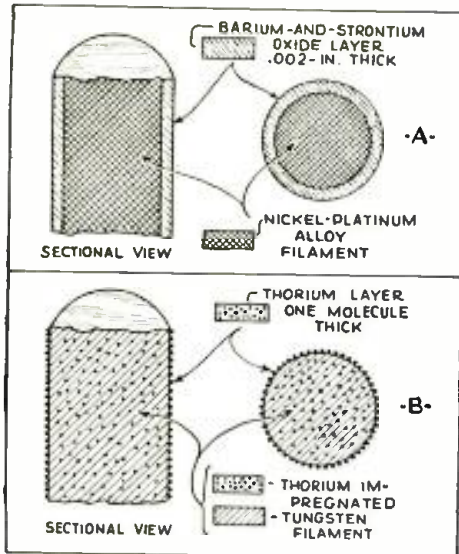

Fig. Q.272  
"Oxide" and "thoriated" tube filaments.

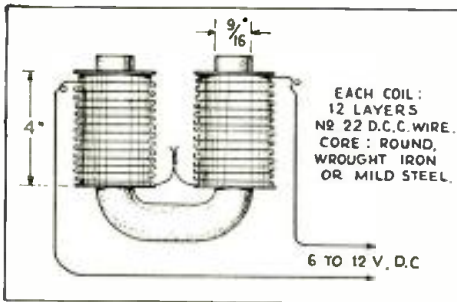

Fig. Q.273  
A small battery-operated magnetizer.

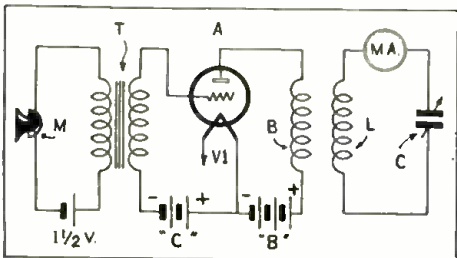
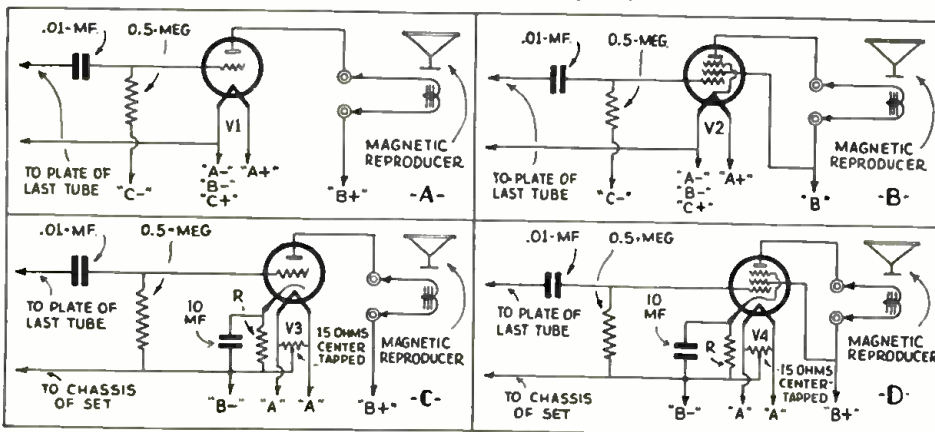

Fig. Q.274. Electro-acoustic wavemeter.

Below, Fig. Q.275. "Add-on" 1 stage amplifiers.



## "TUNGSTEN," "OXIDE" AND "THORIUM" TUBE FILAMENTS— REACTIVATION

(272) Mr. A. N. A. Baeps, Jenkinstown, Pennsylvania.

(Q.1) What is the difference between tube filaments classed as "tungsten," "oxide," and "thorium"?

(A.1) Tungsten-filament tubes are those having filaments made of solid metallic tungsten. Due to the strong affinity which the tungsten electrons have for one another it is difficult to liberate them from the filament. The electrons are released only by raising the filament heat to a very high degree. Now, if there were some way in which the electron affinity could be reduced, there would be less difficulty in obtaining a copious electron flow with moderate filament temperatures. Here is where the oxide-filament tube enters the picture.

Oxide-filament tubes are those having filaments of a solid metal, as for instance platinum, or, less expensively, a nickel- or iridium-platinum alloy, over which there has been placed a film of alkaline-earth oxides having extremely low electron affinity.

Now, our filament will not be called upon to liberate electrons directly—it has only to bring the oxides to a moderate temperature, whereupon the oxides themselves liberate electrons freely.

The oxide-coated filament is represented in greatly magnified proportions at A in Fig. Q.272. The oxide layer has a thickness of about .002-in.

This layer may peel and scale from the filament, leaving the hot tungsten filament to brilliantly shine through in spots, without greatly affecting the operation of the tube. For the filament is radiating plenty light but very few electrons, in comparison to the far lower affinity oxide layer that remains adhered to the filament, and yet which only reaches a dull-red glow.

There is a remedy, however, for the peeling propensity of the coated filament. The solution lies in the use of an alloy-metal instead of a single-metal filament, the electron affinity of the former being considerably less than that of the latter. A suitable alloy is secured by impregnating a tungsten filament with thorium.

The thorium, or thoriated-tungsten filament has the thorium content evenly distributed throughout the body of the wire, in the manner represented at B in Fig. Q.272.

If this thorium remained inside the tungsten it would be of no benefit, once the surface thorium was used up. The trick is to get it to lose, throughout the filament, its

affinity for the tungsten. This it does as the tungsten reaches operating heat. There is formed on the surface of the tungsten a "perspiration" of thorium which continues to boil to the surface as rapidly as it evaporates, thus continuously maintaining a surface layer of thorium. As the illustration shows, this layer is only about 1 thorium-molecule thick.

This boiling-out process continues smoothly, maintaining a uniformly active surface condition, throughout the life of the tube, provided the filament voltage is not increased more than 10% above the rated value.

(Q.2) Can all of these tubes be reactivated?

(A.2) It is possible to "play around" with both the oxide-coated and the thoriated-tungsten filaments, and secure very creditable reactivation of both types. (The tungsten filament tubes cannot be reactivated.)

Tungsten filaments are used in the following tubes: 71, 12, 01, and 00. The last of the tungsten-filament type tubes was made in about 1926.

Thoriated-tungsten filaments are used in the following tubes: 01A, 00A, 10\*, 20, 22, 40 and 99. The last of the thoriated-tungsten filament tubes were produced about 1928. Oxide-coated filaments are used in all heater-type tubes, in addition to the following types: 1A6, 2A3, 6A4, 10\*, W111, WX12, 12A, 19, 26, 30, 31, 32, 33, 34, 35, 46, 47, 48, 49, 50, 71A, 5Z3, 80, 81, 82, 83.

\*Many tube manufacturers produce the type 10 in both oxide-coated and thoriated-tungsten filament; the "oxide" tube operates with a considerably lower filament temperature.

Oxide-coated types including "indirect heaters," such as the 27, may be reactivated by employing the process described in detail in the article, "How to Reactivate Oxide-Coated Filaments," RADIO-CRAFT, October 1932, pg. 220.

Thoriated tungsten filaments may be reactivated by first lighting the filament for 10 seconds at a flashing potential 400% greater than the normal filament potential, and then operating the filament for 30 minutes at an aging potential 50% greater than the normal filament potential. If at the end of the half-hour the minimum normal emis-

(Continued on page 119)

GRUNOW MODEL 1101 REMOTE CONTROL 11 TUBE SUPERHETERODYNE

(Utilizes Si-Lec-Trol remote-control tuner 2A chassis and amplifier 9B chassis. Incorporates A.V.C., inter-station noise suppression, 10 station pre-selection, parallel push-pull output triodes, tone control, and 6F7 combined first-detector and oscillator.)

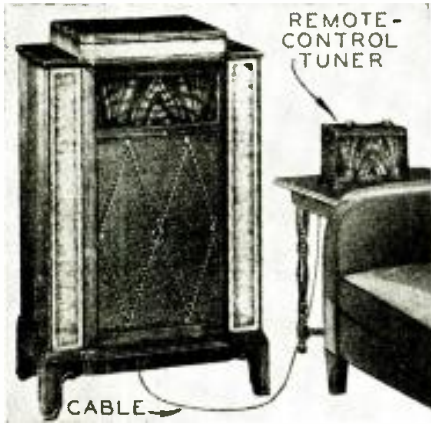

making contact the suppressor-grid voltage is considerably reduced (as determined by the position of R) and reception is then obtained.

Power to the 9B amplifier unit is controlled by a relay contained in the switch box.

Tube Type	Plate Volts	S.-G. Volts	C.-G. Volts	Cath. Volts
V1	90	90	0.5†	0
V2	90	67	1.5†	2.4
V3	230	60	0.5†	0
V4	28**	—	0.5	0.5
V5	200	—	0.5*	12.0
V6	200	—	0.2††	38.0
V7	250	—	50.0	28.0
V8	250	—	50.0	28.0
V9	250	—	50.0	28.0
V10	250	—	50.0	28.0
V11	400(A.C.)	—	—	—

† Correct reading across 75 ohm section of voltage divider, 2.0 V.

†† Correct reading across 400 ohm section of cathode resistor, 3.6 V. \*Correct reading across 1,060 ohm section of voltage divider, 12.0 V. \*\*Read with 150 V. meter.

These figures are taken at a line potential of 112 V., and with the volume control at minimum. The suppressor-grid potential of V3 is 2.6 V. The diode plate to cathode potential of V4 is 20 V.; V5, 0.5-V. The triode control-grid to cathode potential of V2 is 2.4 V.; the triode plate, 60 V. The voltage readings for the tube element connections are read to the respective cathodes.

In aligning the I.F. section connect the service oscillator to the control-grid of the first-detector section of V2, through a .25-mf. condenser to the grid lead of the oscillator section of this tube, in the 2A chassis. Compensate the A.V.C. operation by using a low output from the service oscillator.

To align the R.F. section connect the service oscillator through a 200 mmf. condenser (to prevent disturbing bias voltages) to the antenna and ground binding posts

This modern set has a sensitivity of about 1¼ microvolts per meter for an output of 50 milliwatts; rated power output, with a power-line input of 160 W., is 12 W. The frequency range is 550 to 1,700 kc.

The receiver operates as a remote control model, the Si-lee-trol or remote control portion (2A chassis) being contained in a small, portable cabinet, and consists of the R.F., oscillator and first-detector units. The I.F. is fed through a shielded cable to the amplifier unit, where it is further amplified.

The second-detector is coupled to the grid circuit of the 78 I.F. tube through a small condenser and the signal amplified by the 6B7 tube is also rectified in its diode section. The rectified current flowing through the resistors connected in the cathode circuit furnishes grid bias for the R.F., first-detector and I.F. tubes, to obtain A.V.C. action.

The Si-lee-trol is a device for limiting reception to only 10 pre-selected stations, inter-station silence being obtained by applying a high negative voltage to the suppressor-grid of the I.F. amplifier except at the time that one of the Si-lee-trol fingers is touching the Si-lee-trol contact. Upon

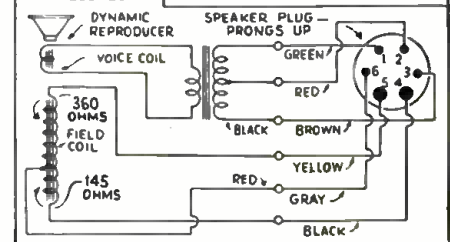
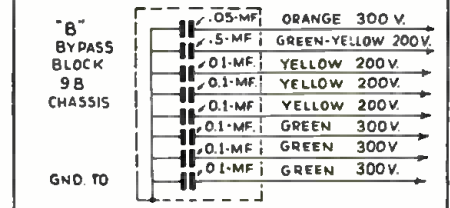
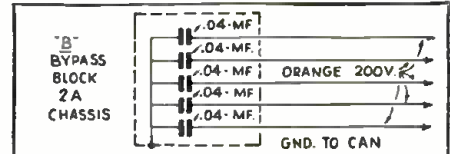

of the 9B chassis. Align at 1,400 and 600 kc.

To align the A.V.C. section, shunt out or disconnect the output meter from the set. Then, increase the output of the service oscillator to the point where the receiver begins to distort, at 600 kc. Reduce receiver output by adjusting its volume control, R, and put the output meter into service.

Increased frequency indication of the

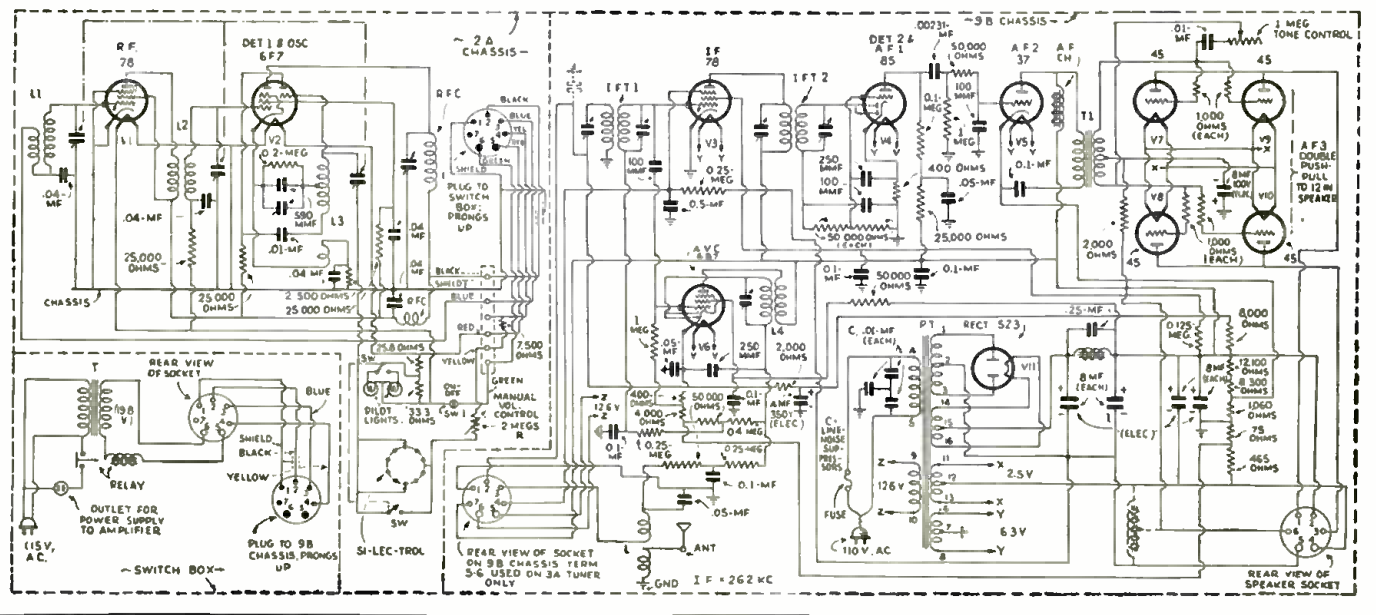

# READERS' DEPARTMENT

A department in which the reader may exchange thoughts and ideas with other readers.

## "6F7 SERVICE OSCILLATOR"

EDITOR, RADIO-CRAFT:

I have built the instrument described in the article, "How to Make an A.C.-D.C. '6F7' Service Oscillator," which appeared on page 534 of the March, 1934 issue of RADIO-CRAFT. However, I did not have a center-tapped choke, so I used an old A.F. transformer. Neither did I have a Wunderlich tube, so I used a type 67 tube instead. (This is a National Union tube with a filament potential of 6.3 V. and current drain of 0.4-amp. This tube may be replaced by a 37; a 56 tube may be used with practically identical results if a transformer secondary is available for lighting this tube.)

The oscillator is very powerful, and I like it very much. I thought some reader of RADIO-CRAFT might like this arrangement, shown in the schematic circuit on this page, better than the one published.

EVARISTE FLEURY,  
58 Falmouth Street.  
Rumford, Me.

## A VOTE FOR 32 V. SET DATA

EDITOR, RADIO-CRAFT:

I believe the 32 V. radio sets deserve a little attention in your service columns. There are a great many of these sets being sold to farmers having 32 V. D.C. lighting plants and as you know these sets are very efficient.

One of the chief difficulties in servicing these sets is the source of voltage, in the service shop, for voltage and current tests in the receiver. One source is a pair of 16 V. demonstrating batteries of 8 cells each, slightly larger than the old Dodge 12 V. auto battery. Another idea is to convert a 32 V. ¼-hp. or so, motor to a generator. I wonder if some 32 V. plant manufacturer does not make a small generator which will provide sufficient current to test 32 V. appliances? Or can someone give us details on how to convert a small 32 V. motor to a generator?

H. E. BECKER,  
Becker Radio Service.  
Grand Ledge, Mich.

There is one concern that specializes in the manufacture of radio sets for operation on 32 V. farm lighting plants. And most of the big set makers now make "32 V." models, the schematic circuits and servicing descriptions for which appear in the "Official Radio Service Manuals." The Latest in Radio

department of RADIO-CRAFT has contained descriptions of motor-generators designed to deliver 110 V., as well as regular "B" potentials, from a 32 V. source. The BOOK REVIEW department has mentioned a new book which contains complete information for the conversion of motors and generators.

One simple way of obtaining good set operation is to utilize a receiver designed for operation on a 6 V. source, as for instance, on auto radio sets, reducing the 32 V. D.C. to 6 V. D.C. by means of a series resistor. Some of these sets require an external "B" supply unit of the ordinary rotary or vibrator type, while many late models incorporate a built-in "B" supply unit.

## HELLO, CANADA!

EDITOR, RADIO-CRAFT:

I was wondering whether something couldn't be done about circuit diagrams and troubles as applied to Canadian receivers.

We read every month about troubles in Zenith, Atwater Kent, Crosley, and many other American sets, but I have never yet seen anything about DeForest Crosley, Rogers, Majestic, Grimes, Williams Serenader and many other Canadian sets. Maybe it is because your Canadian readers do not trouble to write in—or don't you think our troubles are interesting to the majority of your readers?

How about it, Canadians? I am sure if we got together we could help ourselves a whole lot.

I have a complete set of service manuals but the chance is only about 50-50 that it will have in it the diagram of the set I am at the moment servicing. I am sure some enterprising publisher could make himself some money by publishing a set of Canadian radio diagrams.

I would not be without RADIO-CRAFT and have been reading Gernsback publications since about 1914 when I saw a trial offer of three ELECTRICAL EXPERIMENTERS for 25c.

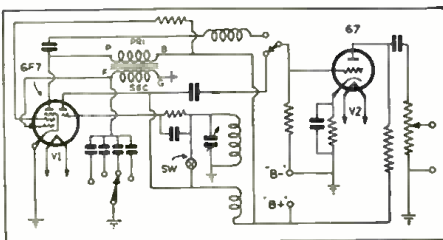

Mr. Fleury adapts the "6F7 oscillator."

I tell you I got more kick out of those three magazines than anything else I have ever read. Baron Munchausen was telling his adventures on Mars, and did I eat them up. I can remember them as if it was yesterday.

I would like to see some articles on test equipment, particularly tube testers and oscillators that could be easily made and be efficient. (I think a tube tester using a neon tube as indicator could be easily made as you described in a past issue, but I seem to have mislaid that issue.)

Would it be possible for you to publish an index of all the "operating notes" you have published so far? Why don't you publish them in a separate book? I am sure it would sell at a profit.

Wishing you every success.

W. M. NYE,  
150 Albert St.,  
Ottawa, Canada

We regret that Mr. Nye has failed to see the operating notes on Canadian radio sets which have been published in past issues of our magazine; subsequent issues will contain additional data—provided our Canadian Service Men come to the rescue of their comrades in set troubles and furnish us with the "fuel." However, they must bear in mind that the majority of our readers live in "the States" and they, too, must be served.

As regards the publication of Canadian radio set diagrams in service manuals, may we point out that one of the objections to, for instance, Supplement No. 5 to Vol. II, and the 1934 Edition of the OFFICIAL RADIO SERVICE MANUAL, was that it contained *too many* Canadian receiver circuits!

Yes, the adventures of the Baron fired our imaginations. However, the wonders of today seem to be catching up with our hero, whose exploits were first chronicled in 1785!

The article, "A Neon-Type, Meterless Checker," appeared on page 413 of the January, 1934 issue. We shall be glad to advise experimenters as to where the special neon tube may be obtained.

It is possible that we shall publish an index of operating notes that have appeared in RADIO-CRAFT but, in most instances, this would merely be duplicating the records kept by the average Service Man. Our BOOK REVIEW department recently mentioned an entire book of indexed operating notes; the volume is quite inexpensive.

(Continued on page 117)

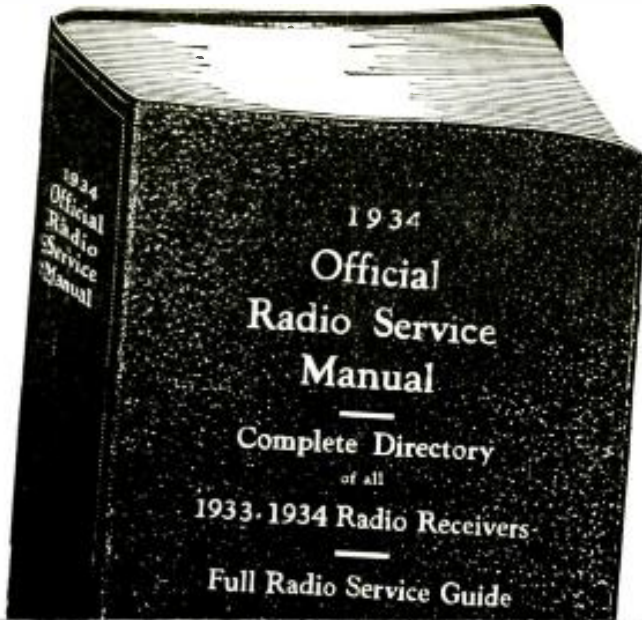

**\$3.50**  
Reg. List Price

400 Pages  
Over 2,000 Illustrations  
9 x 12 Inches  
Flexible, Looseleaf  
Leatherette Cover

## There's plenty of Servicing Material in the NEW 1934 Manual

THE necessity of GERNSBACK Manuals in the radio field has been shown by the fact that the total sales of the first three OFFICIAL RADIO SERVICE MANUALS, including the new CONSOLIDATED EDITION, now exceed 80,000 copies. Radio Service Men and others engaged in various branches of radio know the importance of such books, and how they must depend upon them for reliable information. Whether for public-address work, tube information or a circuit diagram, the material needed is certain to be found in one of the OFFICIAL RADIO SERVICE MANUALS.

In preparing this new edition many of the outstanding problems of the Service Men have been considered—methods of servicing, the new equipment constantly needed to cope with new tubes and sets, and the other fields of radio, such as public-address systems, short waves, auto radio and others.

The illustrations in the 1934 Manual are more explicit than before; inasmuch as the diagrams are not limited to the schematic circuit, but other illustrations show the parts layout, positions of trimmers, neutralizers, etc. There are hundreds of new circuits included, and not one from any previous editions of the manuals has been repeated. *This we unconditionally guarantee.*

As in previous years, the 1934 Manual also includes a FREE QUESTION AND ANSWER SERVICE. In each book will be found 25 coupons, which entitle you to free consultation on any radio service topic. These coupons give you a complete mail service—questions on servicing and operating any set or circuit are answered promptly and accurately by the editors. Remember that, at the regular rate of 25¢ per question which is usually charged by radio magazines, this service alone is worth \$6.00. And for the Manual, we charge only \$3.50.

It is quite evident that the 1934 Edition of the OFFICIAL RADIO SERVICE MANUAL is a decided improvement over previous volumes.

### ORDER YOUR COPIES NOW

It is important to every Radio Service Man and Dealer to get his copy of the 1934 OFFICIAL RADIO SERVICE MANUAL now. The new book will prove itself to be invaluable as those volumes of previous years.

No need to delay sending us your order—the 1934 MANUAL, like its predecessors, is a necessity in your business. We strongly advise you to order your copy today.

**GERNSBACK PUBLICATIONS, INC.**  
99 Hudson Street New York, N. Y.

### Contents of the 1934 Manual in Brief

- Diagrams and service notes, more complete than ever before in any MANUAL. Not merely the schematic hook-ups will be found, but chassis drawings showing parts layouts, positions of trimmers, neutralizers, etc.
- Voltage readings for practically all sets, as an aid in checking tubes and wiring.
- All values of intermediate-frequency transformers used in superheterodynes, with the manufacturers' own suggestions as to correct balancing.
- Detailed trouble-shooting suggestions and procedure as outlined by the manufacturers' own engineers—in other words, authentic "dope" right from headquarters.
- Values of all parts indicated directly on all diagrams.
- Section for reference to A.C.-D.C. cigarbox midsets.
- Section for reference to public-address amplifiers.
- Section for reference to short-wave receivers.
- Section for reference to remote-control systems.
- A complete compilation of radio tube data, covering both the old and the many new types.
- Section devoted to test equipment, analyzers, etc., with full diagrams and other valuable information.
- A complete list of American broadcast stations with their frequencies in kilocycles; extremely useful in calibrating and checking test oscillators and in calibrating receivers.
- Free Question and Answer Service, the same as in our last two Manuals.
- No theory; only service information in quickly accessible form.
- Absolutely no duplication of any diagrams; nothing that appeared in any of the previous Manuals will appear in the 1934 MANUAL. This we unconditionally guarantee.
- A handy, easily-consulted master index making it easy for you to find almost anything pertaining to your service problem instantly. This index includes all the diagrams published in all the previous GERNSBACK Manuals, as well as the 1934 diagrams. A big convenience and time saver!

### Clip — Mail This Coupon Today

GERNSBACK PUBLICATIONS, Inc.  
99 Hudson Street, New York, N. Y.

Gentlemen: Enclosed you will find my remittance of \$3.50 for which you are to send me, Postage Prepaid, One Copy of the 1934 OFFICIAL RADIO SERVICE MANUAL. [Send remittance by check or money order; or register letter if it contains cash, currency or unused U. S. Postage stamps.]

Name .....

Address .....

City ..... State .....

RC-834

## BOSCH MODEL 360 ALL-WAVE (15 TO 550 METERS) 7 TUBE SUPERHETERODYNE

(Various styles of cabinets—and proportionate-size reproducers—are designated by supplementary letters added to the above chassis-model number. This chassis incorporates A.V.C., tone control, and a band selector to prevent image-frequency interference.)

A feature of this instrument design is the exceptional care that has been exercised to prevent the reception of image-frequency signals. An R.F. circuit band-selector is used, in addition to high-selectivity characteristics in the I.F. circuit.

Operating bands are distinguished by dial color: black, 510 to 1,500 kc.; green, 1,500 to 1,800 kc.; red, 3,500 to 9,000 kc.; and; blue, 8,000 to 20,000 kc.

Power consumption, 60 W., at 115 V., line potential. Control-grid bias voltage of V<sub>6</sub>, across R16, 22 V.; output of V<sub>7</sub>, 360 V. Following are operating voltages measured to ground:

Tube Type	Plate Volts	S.-G. Volts	Cath. Volts
V1	220	40	2.8
V2	75	—	0.0
V3	220	95	2.0
V4	240	95	2.7
V5	90	—	1.4
V6	235	240	0.0

The control-grid of V<sub>2</sub> has a potential of 25 V. A service oscillator with output calibrated in microvolts is required. Note that no attempt should be made to re-align the set unless it is practically a certainty that correcting faulty circuit conditions (defective condensers, resistors, tubes, etc.) will not bring the set operation up to par.

### Broadcast Band

To align the broadcast band, first adjust the I.F. circuits. Tune the service oscillator to 456 kc., and adjust its attenuator for an output of about 20,000 microvolts, and feed the oscillator signal to the control-grid of V<sub>4</sub>.

Adjust the small screws in the front of I.F.H.3 for maximum response (reducing the service oscillator output to 5,000 microvolts).

Adjust the alignment screws of I.F.T. 2 for maximum response to a service oscillator signal at about 1000 microvolts, with the test signal introduced into the control-grid circuit of V<sub>3</sub>. Service oscillator output for final sensitivity adjustments, about 300 microvolts.

Adjust I.F.T. 1 aligning screws, with a service oscillator input to V<sub>1</sub> of about 50 microvolts; final test signal value, about 20 microvolts.

Having completed adjustment of the I.F. circuits, the broadcast-frequency circuits can now be aligned.

Set the signal generator to 1,500 kc., with input from the service oscillator to the control-grid of V<sub>1</sub>. Place the pointer of the radio set to the 1.5 mark on the dial. Adjust the trimming condenser screw in the top of the rear shield container until the signal is tuned in. (This screw is usually designated by a red color.

Having obtained resonance at this point, tune the service oscillator to 600 kc. and the set pointer to the 0.6 mark on the station indicator, and adjust the other screw in the shield container for maximum response.

Now, re-tune the set and service oscillator to 1,500 kc. and make whatever readjustments of the first (red-coded) screw are necessary to secure accurate alignment with the scale reading.

Next, connect the service oscillator to the antenna lead, making sure that there is an antenna equivalent capacity (about 200 mmf.) in the circuit.

Continuing the adjustments at 1,500 kc., align the tuning condenser trimmers (the first and second sections, from the front of the set) for loudest response; check sensitivity and calibration at several points on the dial, including checks as follows: 1,500 kc., 5 microvolts; 1,000 kc., 5 microvolts; 600 kc., 10 microvolts. This completes the broadcast-band adjustments.

Do not attempt to adjust the short-wave circuits by means of a service oscillator that secures its short-wave signals as the harmonics of broadcast-band frequencies, as this will usually result in the adjustments going so far off normal as to require factory service (states the manufacturer). Included in 3 available types of suitable test instruments is the RCA model TMV-18.

### Green Band

Adjust the service oscillator output to a frequency of 3,600 kc., set the radio-set pointer at the 3.6 mark on the dial, and adjust for maximum signal strength the trimming condenser (red-coded) in the right-hand front shield container. Next, adjust the service oscillator to 1,600 kc. and the dial scale pointer to the 1.6 mark, and trim the opposite condenser in the shield can for maximum volume. Return to 3,600 kc. and repeat the adjustment.

In adjusting to 3,600 kc. it is possible to obtain two settings for different positions of the trimming condenser in the shield container. This merely denotes resonance to the plus and minus frequency between the set oscillator and service oscillator frequencies which will give the correct I.F. The correct setting of the trimming condenser is the one wherein the screw is turned furthest out. In any event, an incorrect setting will always be denoted by lack of sensitivity when the set and service oscillator are tuned to 2,300 kc. (mid-band). This valuable sensitivity check should indicate as follows: 3,600 kc., 10 microvolts; 2,400 kc., 10 microvolts; 1,600 kc., 5 microvolts.

### Red Band

Adjust the service oscillator to 8,000 kc. and tune the receiver dial near 8.0, noting the exact point of resonance; duplicate this procedure with the service oscillator re-tuned to 4,000 kc. and the set dial adjusted near marking 4.0.

Next, adjust the set and service oscillator padding condenser (rear unit on right-hand side plate) until the service oscillator signal is received.

Re-tune the set and service oscillator to 8,000 kc. and observe the pointer setting and set sensitivity. Slight deviations from calibration can be compensated by manipulating the stiff wires connecting the oscillator coil to the switch.

### Blue Band

Set the service oscillator for an output of 20,000 the service oscillator signal is received on the dial kc. and tune the set to this frequency, noting where scale. Then set the service oscillator at 10,000 kc. and adjust the set oscillator padding condenser (front unit on side plate) until the service oscillator signal is tuned in at 10 on the dial scale. Now retune the service oscillator and the radio set to the 20,000 kc. setting.

Located on the underside of the base, and adjacent to the switch and high-frequency selector coils are 2 trimming condensers which are used for correct adjustment at this high frequency. Increase the setting of the service oscillator attenuator until its signal can be tuned in at 2 points on the dial (say, at 20 and 19). Then, with the set pointer at 20, adjust these trimmers for maximum response, decreasing the service oscillator output as far as possible. At the correct adjustment a very loud signal will be received at 20, and only a feeble one at 19.

Note that the factory diagram does not indicate all of the component values. The supplementary figures are as follows: Voltage divider R3, section a, 1000 ohms, .05-W.; b, 12,000 ohms, 2.13 W.; c, 8,000 ohms, .313-W.; d, 6,000 ohms, .266-W. Tone control resistor R15 has a value of 0.5 meg. Resistor R15 is a 50,000 ohm, .25-W. unit. Condenser C12 has a value of .05 mf.; C43, 0.1-mf.

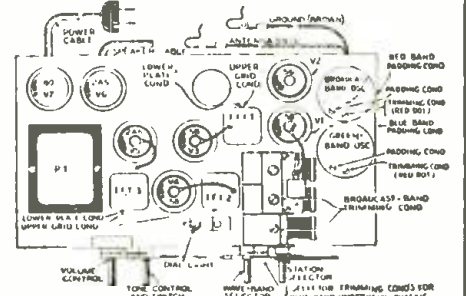

In this illustration are shown the locations of all the aligning units.

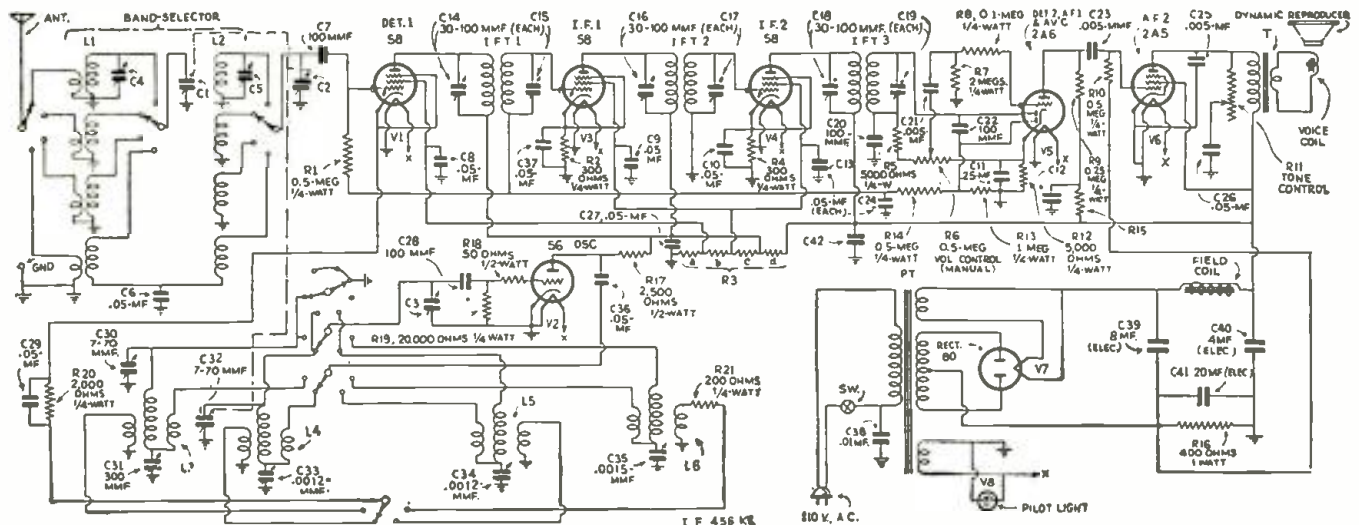

Schematic circuit of a representative, reliable, moderate-priced all-wave set.

## SERVICING PROFESSION

(Continued from page 88)

You be the judge—I made the money. This little example was not the only one; many others followed. If you make an effort to please the public, they will find it out and you will not have to worry about not having enough work. Naturally profits also increase when "re-hash" service calls are infrequent.

### "Don't Take Anything for Granted"

Another rule I would like to mention at this time is: Don't take anybody's word for anything.

One time a customer brought in to the shop, an all-electric set, saying he could not get it to work and that it just came out of a service shop but still wouldn't "percolate." I took the chassis and speaker out of the cabinet, set it upon the test bench and connected it all up. As the customer had packed the tubes in a separate box, I noticed that he had a complete set of new tubes and from a dealer whom I knew to be very careful when selling tubes to test each one out, and then date and guarantee them. I placed the tubes in the set, turned on the power and what reception I did get. The set worked great. The customer said: "That's all right but let it run awhile and then see what happens." The set played about 50 minutes and then dropped down to less than one-third volume and 10 minutes later stopped. I was surely puzzled and worked on the set all night. I even took every piece off and tested it separately and put it back together again. Everything would test O.K. but still the set would stop operating after running about an hour. Along in the wee hours of the morning I became very provoked and just about tore my hair; to let a set get me this way was maddening! I decided to find the trouble if it was the last thing I ever did! I left the shop and went out to get something to eat and cool down. I came back and put in a new set of tubes, turned it on and sat down to wait out the hour. I sat there 2½ hours and it never faltered!

I had tested each of those tubes time after time but did not wait until the faulty tube reached the break-down point, depending all the time upon the fact that the tubes were new. I went home and got about two hours sleep, went back to the shop and started testing tubes. I put the set of 27s in a pre-heater for one hour and then tested them. I found a bad 27. It would hold up and then die down. Did you ever have a like experience? You are not a full-fledged radio Service Man unless you have been dumb and fooled at least a half-dozen times.

I must repeat another experience at this time, the moral of which I will leave entirely up to you.

### Write Your Own Moral To This One!

I had a Service Man working for me who was an exceptionally fine technician and knew his stuff. A customer brought in an 8 tube battery set from the country. This Service Man went over the set, repaired it and had it on reception test. The set worked well except that it did not have enough "C" battery on the first A.F. tube. This "C" battery current came from the "C" battery through a resistor so this Service Man had to disconnect the set, change values in the resistor network and again connect the set back up, for trial.

About this time the customer returned for his set. The Service Man stepped up to the customer and asked him to come over to the set and hear it play. The Service Man started in to connect it up; one of the "B" battery wires fell out of his hand across the "A" battery on the set binding post strip and—bingo! You know the rest—8 new type 30 and 31 tubes at \$2.00, each. This Service Man became violently mad, jerked the wires off the set, slammed the set back across the bench, pulled out the tubes and threw them on the floor and jumped on them. The next thing I knew the customer picked up his set and out the door he went. About an hour later the Service Man moved down the road with his tool case. (We contend that it is poor practice to permit customers in the service shop—demonstrate the set on an outside counter.—EDITOR)

## Cap'n Henry pilots Mary Lou to finer radio reception

—AND CHARTS A COURSE FOR EVERY RADIO LISTENER



Charles Wunnington as Cap'n Henry



## FOR THE REAL JOY OF RADIO PUT IN NEW RCA MICRO-SENSITIVE RADIO TUBES

**F**OR true-to-life reception a radio tube must be sensitive enough to pick up a microscopic electrical impulse—the millionth part of a volt. In RCA Radio Tubes you will find such "Micro-Sensitive" accuracy. Have your RCA Radio Tube agent test your tubes

today. Replace worn tubes only with radio tubes guaranteed by RCA Radiotron Co., Inc., to give these 5 big improvements: **1** Quicker Start. **2** Quieter Operation. **3** Uniform Volume. **4** Uniform Performance. **5** Every Tube is Matched.



# AMERICA TURNS TO MIDWEST!



## AMAZING NEW

# Super Deluxe 16-TUBE ALL-WAVE RADIO

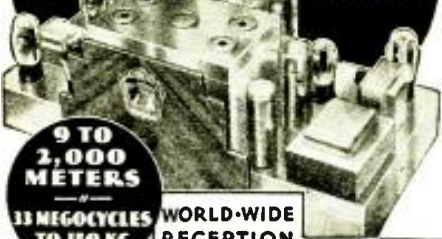

9 TO 2,000 METERS  
33 MEGACYCLES TO 150 KC WORLD-WIDE RECEPTION

**B**EFORE you buy any radio, write for big new FREE Midwest catalog printed in four colors. It has helped thousands of satisfied customers save from 1/3 to 1/2 on their radios . . . by buying direct from the Midwest Laboratories. You, too, can make a positive saving of from 30% to 50% by buying a Midwest 16-Tube Super Deluxe ALL-WAVE radio at sensationally low direct-from-laboratory prices. They bring in broadcasts from stations 10,000 miles and more away . . . and give complete wave length coverage of 9 to 2,000 meters (33 megacycles to 150 KC). These bigger, better, more powerful, clearer toned, super-selective radios have FIVE distinct wave bands: Ultra-short, short, medium, broadcast and long . . . putting the whole world of radio at your finger tips. Now, listen in on all U. S. programs . . . Canadian, police, amateur, commercial, airplane, and ship broadcasts.

**\$49.50**  
**NEW LOW PRICE**  
WITH NEW DELUXE AUDITORIUM TYPE SPEAKER

(less tubes)  
**Terms AS LOW AS \$15.00 DOWN**

Try this Midwest radio for 30 days before you decide. New four-color catalog pictures a complete line of beautiful, artistic consoles and chassis. See for yourself the 40 new 1934 features that insure amazing performance. These features include: Automatic Select-O-Band, Amplified Automatic Volume Control, 16 New Tube Tubes, Balanced Unit Superheterodyne Circuit, Automatic Tone Compensation, 29 Tuned Circuits, 7 KC Selectivity, etc. These and many additional features are usually found only in sets selling from \$100 to \$150! Write for FREE catalog.

### DEAL DIRECT WITH LABORATORIES

Increasing costs are sure to result in higher radio prices soon. Buy before the big advance—NOW!—while you can take advantage of Midwest's amazingly low prices. No middlemen's profits to pay. You save from 30% to 50% when you buy direct from Midwest Laboratories—you get 30 days FREE TRIAL—as little as \$5 down puts a Midwest radio in your home. Satisfaction guaranteed or your money back.

**SAVE UP TO 50%**

**FREE 4-COLOR CATALOG**  
**SAVE 30%**  
MIDWEST RADIO CORP., Dept. 533, Cincinnati, Ohio, U.S.A.  
Cable Address: Miraco, All codes

**RUSH THIS COUPON FOR AMAZING 30-DAY FREE TRIAL OFFER AND NEW 1934 CATALOG**

**MIDWEST RADIO CORP.,**  
Dept. 533  
Cincinnati, Ohio.

Without obligation on my part send me your new FREE 1934 catalog, and complete details of your liberal 30-day FREE trial offer. This is NOT an order.

Name \_\_\_\_\_  
Address \_\_\_\_\_  
City \_\_\_\_\_ State \_\_\_\_\_

**AGENTS! Make Easy Extra Money**  
Check Here for Details

The only reason I relate these experiences has been to point out faulty procedure and profitable methods to operate a radio shop instead of making a set of "do and don't" rules. Some of these experiences happened in the "old" days, but they still happen today.

### Purchasing Test Equipment

Concerning service test equipment, thank goodness the test equipment of today has changed to incorporate basic designs, and the new instruments of today will be with us for a year or two at least. I strongly advise the Service Man to charge enough for his work so that he can take a small percentage from the earnings of each job to be applied to the purchase of new test equipment, tools and machinery so as to enable him to keep up-to-date in his shop. This is the only way to make headway and keep abreast of the times.

There is a definite ratio between the earning power of the radio shop to the class and expense of test instruments to purchase; there are very few occasions when a very expensive test instrument would be justified. That is, supposing there was available some complicated laboratory test instrument almost superhuman in operation which would enable you to make much quicker and more accurate analyses, and the use of which would cut in half your cost of time to perform certain repair jobs in a shop running a fairly heavy amount of work; under these conditions you could pay out the cost of this test equipment in, say, 2 years time—for this instrument would commence to pay back right from the start of its use. You would be justified in purchasing it. However, your shop would certainly have to prove this instrument was needed very greatly.

Let's go into this subject from the angle of elements and compare radio sets with other commercial machinery. To the writer, radio is a very fascinating subject because of these elements. When you purchase an automobile and you fill up with gas and all you are most likely to get to the place where you will want to go without an outside element preventing you. However, with a radio set, you set it up, put in the tubes, and turn on the power—but, you can't say to yourself, "I am going to tune in on such-and-such station a fairly good distance away." You don't know, you merely hope that you will get this station, yet the set is mechanically perfect, electrically perfect and will operate—except for the variable elements which enter into reception. Such elements as fading, man-made static, poor reception due to daily changes in reception conditions, electrical storms, power line variations, and station congestion, will be encountered.

Let me give an example concerning how actual proof that a device will work plays an important part in successfully operating a service station. I worked in a motor rewinding shop and when a motor came in to be rewound, after having burned up, we would rewind it and put it on a horsepower test. We would insert our ammeters and voltmeters on the power supply lines. Then we would put a pulley on the motor and apply the various springs and weights to this pulley. This would register the horsepower being applied with the motor under test and we would compute our power applied, against the power the motor delivered, and would have a fair idea that the efficiency of this motor was exactly as specified on the name plate on this motor. The customer was then entirely satisfied.

### Test-Instrument Inventors, Please Note!

Now supposing that in our radio repair work we had some kind of a moderate priced instrument, simple to operate that we could similarly make tests with. Such as a tube adapter that would measure the "gain per tube per stage" and compute against the manufacturers data sheets that he would supply. How much better we could render our service and what a satisfaction the customer would feel. The writer may have entirely the wrong idea but would like to see comments from other Service Men in the field. (Editor's note: An instrument for the Service Man which will permit gauging a receiver's efficiency was described in the July, 1934 issue of RADIO-CRAFT, in the article entitled, "A Set Sensitivity Tester.")

Now about "side lines" to the service shop. The addition of side lines to the radio service shop entirely depends upon the size of your community. At the present writing a radio shop taking care of the following: radio sets, automobile receivers, public address systems and office call systems, has pretty near enough work to keep a corps of expert specialists busy. However, the very nature of the electrical work required in radio servicing, the type of equipment and tools used, besides his natural training, make the Service Man very adaptable to the varied demands in efficiently servicing electrical household appliances of all types, including vacuum sweepers, mixers and ultra-violet ray equipment. There will be a little extra study required to fit the Service Man to this appliance field; however, not all Service Men will care to do this kind of work. So, with the advent of air conditioning, refrigeration, electrically-operated furnaces and oil burners, or any combination of the above, desirable field work is now available to sustain your repair shop if there is not sufficient radio work obtainable. In concluding this treatise I would like to deal with the subject of obtaining new customers.

### Obtaining New Customers

Never will I forget an article I read about a college professor addressing a class of graduating medical students who were to enter the field of battling for a life's existence. The professor did not go into a lengthy and eloquent speech of what the medical field was or had been. But as he took the floor, he spoke with a sharp commanding voice, "Graduates, to each and every one of you, the best thing I know of for you men to do is to take an agency for some insurance line, book agency, magazine subscription agency, or piano agency and go out and sell your wares to the public. Take a whole year off and go from place to place selling. I know of no more fitting training and experience than this will afford you when you come back to follow your profession and open up your practice, because when you open up your office and hang up your shingle, you will have ever before you the art of selling your services, since you must sell yourself to the public, before you can sell your services." How well this applies to the Service Man who intends to open up a radio service shop who must continually sell himself in order to sell his services! A little study on salesmanship will certainly pay big returns.

Now that the radio field has public address systems and small inter-office call systems, there is no reason why many new customers cannot be added. With a little study and planning, this will open up a nice field for future business. There are a lot of places where the inter-office call system can be put to use. Such installations are not very expensive, but will require salesmanship and some pioneering in order to get this type of business started. The field for P.A. systems to be used in show window demonstrations is another place where new customers may be added. Public dance halls constitute another field where P.A. systems find valuable use.

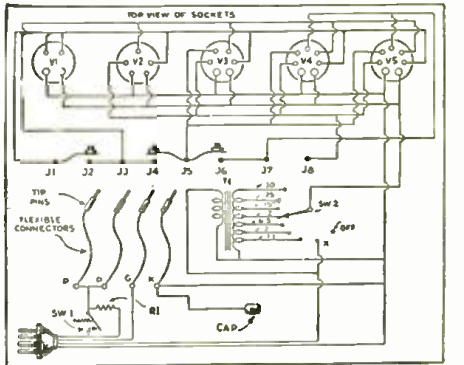

SAVE YOUR OLD TUBE TESTER  
THE correction-circuit above indicates the cap connection in Fig. 1, page 602, in the April, 1934 RADIO-CRAFT.



# BUD'S NEW PORTABLE P. A. SYSTEM ●

**5 DAYS  
FREE  
Trial**

**FOR IN OR OUTDOOR USE**

**Try BUD  
Sound Equipment  
FOR FIVE DAYS  
ABSOLUTELY FREE!**

You've wished for it! You've needed it! You've asked for it! Here it is! A brand new, highly efficient, powerful portable P. A. system for BOTH IN AND OUTDOOR USE! Think of it! A portable P. A. system which features, as standard equipment, a high quality condenser microphone! With this new system you can cover a large sized theatre or a 2,500 outdoor gathering. Speakers are mounted on their own adjustable stands, and housed in a new and improved type of all aluminum baffle design. Write for details of BUD'S amazing FREE FIVE DAY TRIAL offer and beautifully illustrated booklet covering our complete line of laboratory-built sound equipment.

**BUD SPEAKER CO. • 1116 Jackson Street, Toledo, Ohio.**



**Combination  
Amplifier &  
Power Supply**

BUD

LABORATORY-BUILT

ELECTRO-DYNAMIC UNITS • CARBON & CONDENSER  
MICROPHONES • 4, 5 & 6 FT. ALL ALUMINUM TRUMPETS  
FIELD EXCITERS • AIR COLUMN HORNS • LOW AND  
HIGH FREQUENCY UNITS FOR WIDE RANGE THEATRE USE.

## SURGICAL ROOM SOUND INSTALLATIONS

*(Continued from page 78)*

and, (5) the control cabinet. These factors are described in greater detail as follows.

The soft-rubber casing, which measures 1½ ins. in dia., fits over the microphone and is provided as a guard to prevent the noise of cloth rubbing against the microphone. (Carrying the jack and plug assembly in the pocket is another aid to quiet operation by preventing mechanical vibration being transmitted through the cord to the microphone.)

The diaphragm of the surgeon's microphone is made of thin aluminum; it is conical in shape in order to provide sufficient rigidity. Impregnated paper rings which support the edge of the diaphragm also provide a degree of damping to reduce resonance and so insure a sufficiently flat response characteristic over the normal voice-frequency range.

The carbon chamber is completely filled in order to render negligible any noise that might result from shifting of the carbon granules when the microphone is jarred or moved about. Electrical connection to the carbon granules is made through two stationary, circular electrodes insulated from each other by a ceramic barrier, the carbon granules being insulated from the diaphragm by a coat of phenol varnish. A grid in the front of the microphone protects the diaphragm from injury.

A fixed condenser shunts the two leads to the microphone, on the microphone side of the connection plug at the end of a 2 ft. length of twin-conductor cord. This condenser absorbs voltage surges which otherwise would tend to arc across the carbon granules, causing them to cohere, when the plug is disconnected from the jack.

Between the microphone and the rack-and-panel amplifier equipment there is interposed a control cabinet. This instrument provides means for supplying the 12 V. required by the

microphone, for suppressing clicks when the microphone is switched in and out of circuit, and for altering the acoustic characteristics to compensate for the conditions under which the surgeon's microphone must operate, for, in this service, the device picks up sound that is rich in low frequencies. If unattenuated, this would result in deep, unnatural reproduction.

The march of time is thus shown to have encompassed one more essential field of operation for the vacuum tube and its associated equipment. (The engineering and installation of the Western Electric system at the Institute of Ophthalmology were the work of the Graybar Electric Co., Inc., in association with James O. Oliver & Co., Inc.)

## BROADCASTING GUIDES AIRPLANES

*(Continued from page 81)*

within one-half of one percent, to ensure equal voltages to the rectifiers. Resistor R4 is added to guard against changes in the resistance of the rectifiers themselves, although it reduces somewhat the sensitivity of the device.

Units R5 and R6 are biasing resistors; R7 provides a grid return for the first R.F. amplifier, V3.

The output of the radio receiver is applied to the rectifiers through the output transformer, T2, thus allowing the rectifiers to operate as the output switching device, in addition to grounding alternately the ends of the loop antenna.

It will be observed from the diagram that the rectifier which draws current has a momentary low resistance to ground, cutting off the other rectifier, which then has high resistance to ground. When the phase of the applied voltage is reversed, the first rectifier

is cut off and the second draws current, and the grounding point of the antenna is reversed about its center point.

### Radio Solves Many Problems

Careful analysis of this brief description brings to light some of the less obvious, but extremely important characteristics of this unique radio direction finder. It has no moving parts to get out of order. The phasing of currents is accomplished automatically. It is non-ambiguous, i.e., it gives only one true course, with accuracy in the order of one degree. It operates on both modulated and non-modulated radio waves without destroying the characteristics of the received signals. Last but not least, its design makes it possible to use it as a unit in conjunction with any standard radio receiver.

The last obstacles to thorough practicability of private flying are being rapidly surmounted by wider use of radio, and the alert radio man will do well to acquaint himself with this next great industry. The country is ripe for privately owned airplanes, reasonably independent of weather. And radio is destined to play a greater and greater role in aviation.

### THE RADIO "CHUKKER"

This is the name which has been given to a unique servicing chart, which presents in convenient form the recommended charges for almost the entire gamut of service operations in connection with the repair of faulty sets.

The "Radio Chukker," which was compiled by Paul G. Freed, of Freed's Radio Co., is available, for a small sum, as a heavy Bristol-board card suitable for wall mounting.

Note that in addition to furnishing recommended fees, this card also speeds service by indicating the probable sources of trouble in most sets, provided the symptoms are known.

# THE TOBE CONDENSER ANALYZER\*

## A NEW INSTRUMENT FOR RADIO SERVICE

CONDENSERS OF PRACTICALLY  
ANY CAPACITY OR TYPE . . .  
ELECTROLYTIC • PAPER • MICA • OIL

Tested Scientifically by the  
Voltage-Resistance-Leakage Method.

1. Measures condenser quality.
2. Indicates poor, leaky condensers.
3. Indicates "shorted" condensers.
4. Detects "intermittent" connections.
5. Indicates "open" condensers.
6. Tests voltages up to 700 volts D.C.
7. Identifies all condensers as "replace" or "good."

AMAZINGLY LOW PRICED!

Complete with valuable text on condensers, one Neon Glow Tube, cord and plug less 01-A tube, only **\$11.40**  
Priced at \$11.70 in Denver and West Coast. Net to Servicemen

TOBE DEUTSCHMANN CORPORATION  
CANTON, MASS.

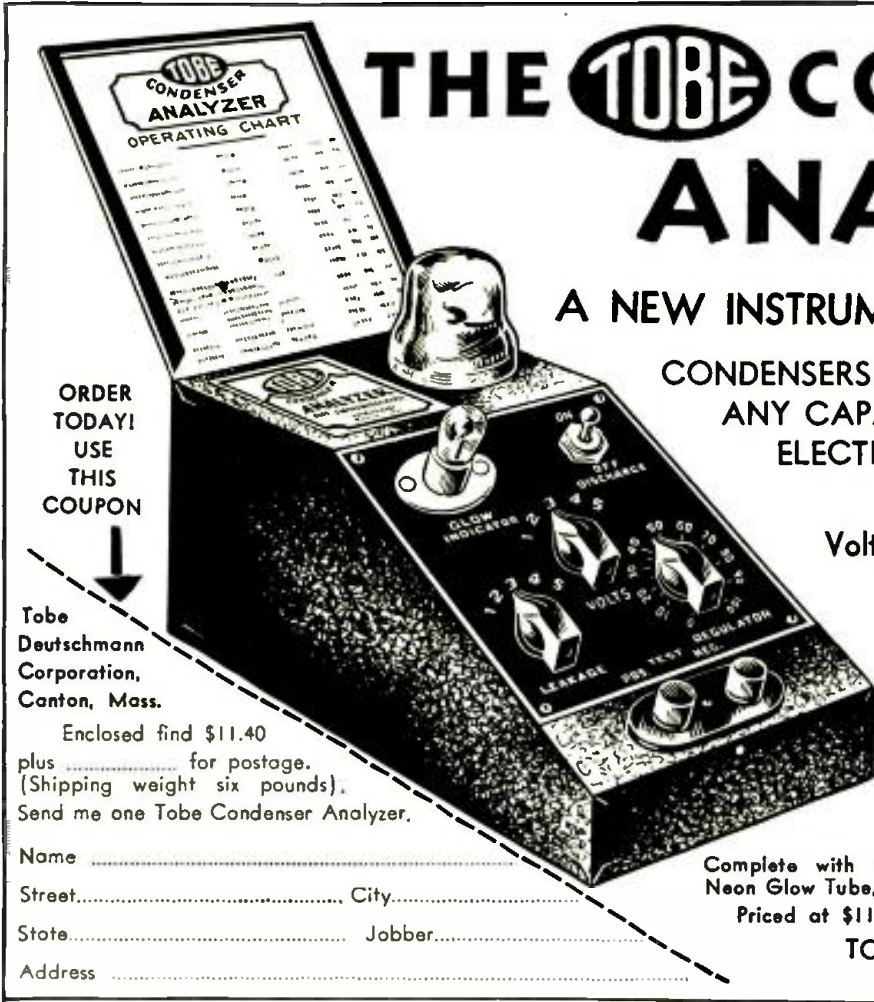

ORDER TODAY!  
USE THIS COUPON

Tobe  
Deutschmann  
Corporation,  
Canton, Mass.

Enclosed find \$11.40  
plus \_\_\_\_\_ for postage.  
(Shipping weight six pounds).  
Send me one Tobe Condenser Analyzer.

Name .....

Street..... City.....

State..... Jobber.....

Address .....

## A "SYNTRONIC" ORGAN

(Continued from page 77)

thetic electronic organ itself, it will be necessary to say a word regarding the preparation of the various important features of the instrument, such as tone synthesis, preparation of the sound films, etc. In Fig. B a musician is shown performing before the studio microphone, which has electrical connection to the visual wave indicating device shown at the left. This device is provided for the purpose of projecting on its visor screen, the wave forms of the sounds which are picked up by the microphone. (See "Orchestra Volume Indicator," RADIO-CRAFT, June 1934, pg. 711.) These sounds may be speech, music, or the effects created by special sound producing devices or musical instruments. It is the duty of the draftsman and calculator shown seated at the drawing board, to make linear graphs of the wave forms of the sound waves which are visualized on the wave indicating device. When it is necessary, the wave forms are modulated or synthesized in graphs, in order to conform with certain requirements or to overcome any unpleasant interferences such as harshness, poor clarity of tone, undesirable general tone quality, etc., for ensuring more perfect reproduction. From the final wave patterns, which have been calculated in the graphs, the mechanic, shown at right, produces sound wave-bearing cams, with the aid of a micrometer wave transferring device. The sound waves are cut into the peripheries of the cams with great precision, since it is purely by mathematical calculation. These cams are made of light opaque material which is easily handled for taking on any peripheral outline, regardless of how fine or intricate the characteristics of the wave patterns are. The enlarging device, at right of this illustration, is provided for the purpose of magnifying sound patterns of these "quality" films, of which more will be said later.

### Simulating Notes or "Pitch"

It will be made more apparent later in this

article, just how the quality and pitch films of this instrument are utilized. In the production of pitch films, the Eremeeff universal recorder, shown in Fig. C, plays an important part. A number, 8 at one time, to be exact, of the afore-mentioned wave-bearing cams are installed in the recorder, where they revolve at predetermined speeds in the path of the variable-intensity light sources that are placed just behind the wall in which the shafts of the cams are journaled. The wave-bearing cams act as light choppers, and each revolves at a predetermined speed, which is just twice as great as the one before it. That is to say, if the first cam revolves 20 times per minute, the second cam revolves 40 times, the third revolves 80 times, the fourth revolves 160 times, etc., each cam chopping a light beam at such a number of times that it produces a "pitch track" on a running raw film, seen in the foreground, at a predetermined representative frequency.

Beginning with the note A (27.5 cycles per second), and ending at the note C (4,185.08 cycles), every frequency of a musical scale is recorded on the pitch film, due to the displacement which takes place in the flicker cabinet, of which the wave-bearing cams are a part. As I have said, there are 8 pitch tracks recorded at one time, each track representing a frequency which is one octave higher than the frequency represented by the preceding pitch track. However, on the raw film, space is left between the 8 simultaneously recorded pitch tracks, which is large enough for 11 more tracks, in order that each track may represent its own frequency, to produce the remaining notes of a musical scale. The device is known as a "universal" recorder since it is very pliable, being capable of producing wave patterns representing sound and music of any desired tone quality, pitch, and volume. The recorder, of course, is also provided for producing quality waves as well as pitch tracks.

The pitch tracks are composed of numerous repeating uniform slits or apertures, which are produced by cams of such shape, that light is permitted to pass through their open-

ings for predetermined periods of time, allowing a definite amount of light to pass. The flicker cabinet is displaced by a novel adjusting means, and functions with the assistance of a micrometer indicating device, so that the amount of movement is gauged by degrees, representing small fractions of a measuring unit.

### Simulating Tones or "Quality"

The method of producing quality films is similar to that of the pitch films. However, in the former, cams with predetermined wave patterns cut into the peripheries, as described, are revolved in the path of the light beams projected on the running raw film. Of course, the quality tracks are produced at predetermined frequencies, to correspond to the frequencies of the pitch tracks. Infinite numbers of different tone quality patterns are cut into the wave cams, and anyone who is skilled in the science of musical sounds understands that every sound of any description has its own peculiar wave form characteristics. (See "The Polytone," RADIO-CRAFT, May 1934, pg. 657; also, "The Radio Organ of a Trillion Tones," January 1931, pg. 402; and, "Drafting Musical Compositions," September 1932, insert pg. 192-B.)

The quality films are recorded in divided sections, for producing "masks." When these quality masks are placed in the electronic organ, they are selectively shifted to desired positions for choice in the variety of tone qualities. The frequencies of the quality tracks are determined by the length of each repeating wave form, and the frequency of the pitch tracks are determined by the size of the space between the pitch slits.

### Two Manuals

The electronic organ which is described in this article, has two manuals. Each manual has its own self-contained sound producing unit. Each unit contains one pitch film and one quality mask, the latter having any predetermined number of divisions which contain different quality patterns as described.

The pitch film is in the form of an endless running belt, which is so spliced, with the aid of microscopic magnification, that the pitch tracks are matched, to avoid any extra parasitic noise resulting from poorly matched pitch tracks. The quality mask, however, is not run as an endless belt in this particular instrument, but rolls over two cylindrical rollers, either by manual adjustment, or by motor. An indicator, which shows the quality selected is also provided, and by referring to Fig. A, the indicator can be seen in the front of the electronic organ.

The enlarger shown to the right, Fig. B, is provided for suitably magnifying the size of the quality masks, for such occasions when a wider mask is more desirable. When it is necessary to have more accurate reproduction of tone, a wider mask is used to advantage. This also permits of employing larger light shutters, which will be explained later.

The inventor of this electronic organ, Ivan Eremeeff, is shown in Fig. C, beside the universal recorder.

### Broadcast-Studio Syntronic Organ

In Fig. 1 there is represented the electronic musical system which is the basis of the electronic organ built for broadcast studios. The pitch film, *a*, is shown riding on several padded rollers with the aid of an induction motor drive, which is brushless for the purpose of avoiding the creation of any unnecessary parasitic noises. The motor is provided with speed controlling means for regulating the rate of travel of the pitch film for maintaining the note A in the International pitch, 440 cycles per second. The quality mask, *b*, is divided into sections, so that it may be retarded or advanced to predetermined positions by means of the manually operated or motorized lever, *c*, which shifts the mask into position with the aid of the push and pull gearing system shown. Said mask shifting is accomplished automatically by the aid of the motor drive, *d*.

The system operates as follows: light from the sources, *e*, which are in the form of several lamps of predetermined intensities for the correct light distribution for the different frequencies of a musical scale, is projected through a selected portion of the quality mask and through the variable transluency disc, *f*, which, with the aid of the co-operative pedal shown, controls the volume of the output, by regulating the intensity of the light passing into the lens shown. From thence, the light passes through the variable transluency disc, *g*, which, by the assistance of its co-operative pedal, produces a variable-speed tremolo effect. Finally, the light falls on the running pitch film, *a*, in such a manner that when any predetermined key of the keyboard shown, is depressed, a light shutter, as *h*, is raised, allowing a slit of light to pass through the quality mask and fall on one pitch track of the film, *a*, the frequency represented by that pitch track being equivalent to the frequency of the musical tone denoted by the predetermined key which was depressed. The light shutters, *h*, ride in the spacers of the diminishing rollers, *i*, which revolve at predetermined speeds in the direction which carries the light shutters downward to their resting position. This arrangement, for producing diminishing effects in the tones, also permits of producing staccato effects.

### The "Sound Effects" Shutters

Each light shutter is provided with a spring attachment, which will be made more apparent when reference is made to the complete assembly unit which will be described later. The springs, when held at a tension, tend to press the light shutters against the diminisher rollers in such a manner that the rollers carry the shutters to their original positions for the purpose of permitting the musical tones to "fade away." However, when the tension of the springs is released, the shutters are free and, after a key is depressed, the co-operative shutter drops by its own weight to its resting position. This permits of producing quick, short tones which compare to staccato tones produced on a piano.

Also, the diminishing device produces effects which are similar to the sustained tones produced by holding the pressure on a piano key, but, of course, the speed of the

diminishing in the electronic organ is adjustable, by the aid of the pedal which is shown having connection to the main shaft of the diminisher, by the slipping clutch which controls the speed of the induction motor drive illustrated.

These musical effects, such as diminishing, tremolo, volume control, etc., are accomplished without causing any interference to the general tone quality which is produced at the time.

The shaft of the lower roller of the quality mask, *b*, is provided with an indicator which has graduated degrees for the purpose of pointing out to the operator the quality selected. After the light has been modulated as desired, it falls on the photo-sensitive element behind the running pitch film, *a*.

Signals are then transmitted to an amplifying system, which includes a mixing element and a required number of reproducers of various frequency ranges. These loudspeakers may be housed in the organ console, or may be placed at any distance from the source of sound. For example, in broadcast work, if it is desired to broadcast the electronic music, one line from the power amplifier is sent to the control room, from whence it is broadcast. Another line may be sent to a reproducer or several reproducers which are placed in an auditorium in which great numbers of listeners are able to hear the output. For a small group of listeners, the loudspeaker which is housed in the console is sufficient.

### Commercial-Type Syntronic Organ

Figure 2 illustrates a single unit of a commercial assembly, which includes keyboard, pedals, motors, etc., as shown in Fig. 2. The film, *a*, is shown riding over the padded rollers with the aid of an induction motor, at predetermined controllable speeds. One of said rollers has spring attachments for providing suitable tension to the running film. The gearing arrangement shown in Fig. 2, for driving the film *a* was not included in Fig. 1, for the sake of simplicity. The quality mask *b*, seen in the foreground, is wound on rollers which have push and pull gearing with the aid of the shaft of lever *c*, by which selective sections of the quality mask are shifted in the path of the light originating in the light sources *e*. As previously mentioned, the quality mask may be adjusted by hand, or may be operated automatically with the aid of an induction motor.

In Fig. E, the light shutters, *h*, and their cooperative diminishing rollers are shown to greater advantage. There are 88 light shutters, and, of course, 88 spacers in the diminisher rollers, *i*. Each roller to the shaft of an induction motor whose speed is controlled by the adjusting means, *j*. The lever, *k*, controls the speed of the induction motor which drives the gears of the rollers driving the pitch film, *a*.

The shutters, *h*, are held at a tension against the diminisher rollers by means of springs, not shown, which connect said shutters to the frame, *l*. When it is desired to operate the diminishing apparatus, the lever *m*, which controls the eccentrics as *n*, is turned in such a direction that the eccentrics press the frame backward, causing the springs to become tense, thus pressing the light shutters against the diminisher rollers in such a manner that they follow the movement of the rollers, and thus, the tones are given a sustained effect. The staccato action has been described with reference to Fig. 1.

### Manual Adjustments

In the illustration of the organ in the console, shown in Fig. A, the various adjusting means such as the device, *j*, the lever, *k*, the lever, *c*, and the lever, *m*, can be recognized protruding from the front and sides. Of course, since the organ console houses two individual units, there are two of each of the above-mentioned adjusting means.

While the parts of Fig. 2 are the same as those shown in Fig. 1, the tremolo-producing device is shown with a slight change. In Fig. 1, the variable transluency disc, *g*, which revolves in the path of light originating in *e*, is controlled by the tremolo pedal shown. However, in Fig. 2, the tremolo pedal is provided for the purpose of dipping the disc, *g*, into the light beam, while the manually operated knob shown is provided

JOIN THE NATIONAL UNION RADIO TUBE PARADE TO PROFIT!

NATIONAL UNION  
SUPERIOR  
RADIO TUBES  
KEENER RICHER TONE  
ON SHORT WAVES  
AND LONG WAVES  
ALWAYS

**PROFIT!** The one real higher the price of National Union tubes means the greater the profit for the radio dealer.

**EQUIPMENT:** Tuning, alignment, service and test equipment are given with National Union radio tubes. The National Union dealer who sells the equipment will be the dealer of National Union tubes.

**STANDARD PRICES:** National Union tubes are sold everywhere at full price to the service men and their stock of accessories with regular discounts for the tubes in full price - 10%.

**PRELIMINARY:** National Union tubes are sold at 10% discount to the service men and their stock of accessories with regular discounts for the tubes in full price - 10%.

**QUALITY:** Still adherence to their standard - the tubes are responsible for the consistent popularity of National Union tubes. Fully guaranteed!

**SERVICE AIDS:** Count, 60% information and - 40% of the cost to service men who buy up with National Union tubes... can't be duplicated from any other single source.

National Union Radio Corporation of N. Y.  
400 Madison Avenue., New York City

Send me details about:

Name \_\_\_\_\_  
Street \_\_\_\_\_  
City \_\_\_\_\_ State \_\_\_\_\_

RADIO-CRAFT for AUGUST, 1934

105

www.americanradiohistory.com

JUST OFF THE PRESS!

**FREE**

**100 PAGES OF BIG VALUES**

You cannot possibly afford to be without this really Valuable Book. WE ARE HEADQUARTERS FOR P.A. SYSTEMS

Buy direct from the manufacturer and pay only one profit!



**ENTIRELY NEW from cover to cover**

Filled with Latest Design Portable, Mobile and Rack and Panel, Public Address Amplifiers, Short-Wave and All-Wave Receivers and Converters, Inter-Office Call Systems, Test Equipment, Replacement Parts, Kits, Tubes, and Accessories—all at Unbeatable

Rock Bottom Prices

Send for Your Copy Today!

**HELPS - YOU - TO - Earn Big Money!**

**OFFICIAL P. A. AMPLIFIER MANUAL AND SOUND SYSTEM TREATISE**

Devoted Exclusively to the Problems Involved in Purchasing, Designing, Measuring, Testing, Installing, Operating, Trouble Shooting, Maintaining, and Money Making Possibilities of Public Address Systems. A vital necessity to everyone connected in any way with Sound systems—Public Address Work—or Amplifiers—Associated Equipment! Complete and Authoritative!

Contains 64 Pages 8" x 10 3/4". Over 150 Diagrams, Charts and Illustrations.

**\$1.00** POST PAID

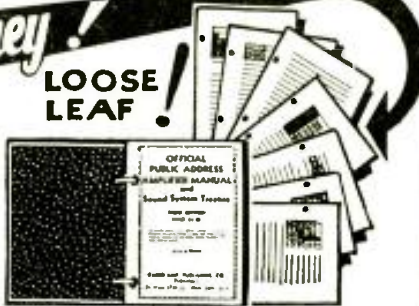

**COAST-TO-COAST PRESENTS A FULL LINE OF**

**1935 P. A. AMPLIFIERS**

*Never before such features!*



These improved modern Amplifiers employ an all-steel black crystalline housing with hinged top and ventilating louvers. Available with optional self-contained "Input-Mixer-Fader" Control Panel, Combination Output Meter and "Mike" Current Meter, Self-Contained "Mike" Current Supply, etc. etc. Entire line, ranging in audio output from 5 Watts to 100 Watts, described in our free catalog shown above.



**COAST-TO-COAST-RADIO-CORP.**  
123 K-WEST 17TH STREET, NEW YORK, N.Y.



**NEW MODEL 77 NEW EGERT SIGNAL GENERATOR**

Calibrated Frequency Range 105-3000 Kilocycles With a 1000 Cycle Modulated Signal.

**OUTSTANDING FEATURES**

- A.C.—D.C. Operation.
- Beautiful 1/10 division New Egert Accurate Reading Dial—No Backlash.
- Frequency Calibrated Range 105-3,000 Kilocycles. Audio Modulation 1,000 Cycles.
- Totally Shielded.
- Etched Metal Panel.
- Sure Tip Jack Connection with Shield Leads.
- Frequency Can Be Read to 1/10 of 1%.
- Extremely Stable Electron Coupled Circuit.
- Supplies Both Radio and Audio Frequency Independently.
- Powerful Signals Available Down to 10 Meters.
- New Tubes—6A7 and '37.

A REAL feature in the Signal Generator is the new WIRELESS EGERT ENGINEERING dial employed. This new dial allows the serviceman to absolutely read accurately as close as 500 cycles at any point of the broadcast band.

Complete With Tubes (List 25.00)

**\$14.95**

Egert Dial

(List 5.00)

**\$2.95**

WIRELESS EGERT ENGINEERING, Inc., 179-R Varick Street, New York City, N. Y.

**When Seeking a Radio School . . .**

Consider the advantages of R.C.A. Institutes



Whether elementary radio principles or advanced subjects, sound applications or practical radio engineering, R.C.A. Institutes is prepared to give you the instruction you need.

Student attending our Chicago School this Summer have added advantage of combining a study of the scientific wonders of the World's Fair.

**RESIDENT SCHOOLS NEW YORK & CHICAGO** with modern standard equipment

**EXTENSION COURSES FOR HOME STUDY** under convenient "no obligation" plan

Illustrated Catalog on Request.

**R.C.A. INSTITUTES, Inc.** Dept. RT-34  
75 Varick St., New York—1154 Merchandise Mart, Chicago

**Buried GOLD**

Silver, iron, etc. Located by Radio. Notary Public Guarantee.

FREE CATALOG!

Write Today

RADIO METAL LOCATING Co.

Box 48 New Orleans, La.

for the purpose of controlling the revolutions of the motor which revolves the tremolo disc. However, the principle and the result is the same. Behind the lens is shown the variable translucency disc whose purpose it is to control the volume.

Behind the running pitch film, a the photo-sensitive element is shown harbored in a metal tube casing, which has an aperture which is just large enough to expose the cathode plate of the photo-sensitive element.

There are 88 light shutters and 88 keys in each keyboard, each shutter having connection to its own cooperative key by means of a flexible ribbon which runs over suitable, very small rollers. Naturally, at the pressure of the key, its cooperative light shutter is lifted. The degree of lift of each individual shutter is controlled so that each frequency of the musical scale has its own predetermined intensity which is gauged according to the law of intensity control in a musical scale, known to those in the piano tuning profession.

The intensities of the light sources, such as c, are also regulated, in order that certain frequencies are permitted to have more light. It can be seen that the aperture in the lamp housing is larger at one end than at the other, for the purpose of allowing a predetermined degree of light to pass.

**A Syntronic-Organ "Orchestra"**

At the present writing, plans are being discussed with a view to a symphony orchestra which is composed exclusively of electronic organs, of which there will be about 35. These instruments are designed to be portable and compact, and will utilize the synthetic wave films as described, for the production of various types of music, such as produced by ordinary well-known musical instruments as the violin, the flute, the clarinet, piccolo, etc., and also music the timbre or tone of which has not been heard before!

In such an orchestra, the individual instruments will, at specified intervals, play with definite qualities. When it is required that the quality be changed, the individual instruments themselves will take on, selectively, an entirely new and different tone.

The tonal effects, such as the tremolo, which produces a rapid or slow fluttering reiteration of the tones, the diminishing or "fading away" of the tones after the performer's fingers have left the keys, the volume control, and the effects produced by the manner of key attack, are all controlled and varied by the individual touch of the artist. That is to say, the player must be an artist, since, in any symphonic music, the many intricacies of music modulation must be completely understood by each participant.

**A New Musical Technique**

The electronic organs permit of the finest musical control and expression, due to those devices which change the musical effects as well as to the many qualities which can be had from the quality masks.

Each instrument has its own output wiring, and in an orchestra composed of electronic organs, there is connection to a common line which feeds a centralized mixer. The orchestra leader will have control over the output of all the instruments by means of regulating the mixer, so that the tones are mixed and altered if necessary before entering the line feeding the loudspeaker system.

For the purpose of "silent practice," each artist will be supplied with earphones, so that he is the only person who is able to hear the output of his own instrument, at times when he does not wish to disturb others.

Fig. D

Figure D shows how sound waves are analyzed, synthesized, and prepared for being photographed on pitch and quality films for the electronic organ. Wave forms are studied under a microscope, sorted and selected, and drawn up in graphs for synthesis. The final drawings of the wave patterns, which are to be utilized in the organ, are obtained only after all corrections, additions, and alterations have been made. In the background of the photograph can be seen a plate of wave-bearing cams into whose peripheries the wave forms are cut in preparation for placement in the universal Eremeeff recorder.

## ALL-WAVE ANTENNAS

(Continued from page 85)

high-quality ceramic), T, as shown in Fig. B.

In Fig. B is shown the complete kit of components that comprise the system shown in Fig. 3A, as follows: 15 transposition blocks (sufficient for an 18 ft. transmission line); 8 strain insulators; 1 "universal" all-wave coupling unit; 100 ft. No. 18 stranded wire; and, 50 ft. No. 14 stranded wire. The No. 18 wire is used for the lead-in. The No. 14 wire is used for the horizontal dipoles, for very short wavelengths. However, several lengths of this wire will be required if the manufacturer's recommendation is to be followed for an all-wave antenna; the total horizontal length then would be 156 ft., 2 ins., (allowing for the central strain insulator), or 78 ft. per section, X.

Run the horizontal wires northwest and southeast. Transmission-line terminals 1 and 2 may be connected to the "Ant." and "Gnd." posts of most radio sets, after removing the ground wire in order to maintain balanced operation of the antenna and lead-in system. If lack of a ground connection results in circuit oscillation or increased hum it will be necessary to use a coupling or impedance-matching transformer. It is recommended that a manufactured unit be used; however, in Fig. 3A construction data is furnished for the experimenter.

Still another, but less desirable method of connecting the transmission line to the radio set utilizes two 400 ohm, 1 W. resistors. One connects in series with the transmission-line connection to the "Ant." post of the radio set, and the other connects in series with the transmission-line lead to the "Gnd." post; the ground wire may then be connected to the "Gnd." post of the radio set.

### Lightning Arresters

It is advisable to use a lightning arrester with any type of antenna. Those designed for use with a doublet antenna are provided with a center-tap which is to be connected directly to a good outside ground (if possible), the remaining two ends being connected to the two terminals of the transmission line, where they connect to the radio set or any coupling unit.

This manner of connecting a doublet-antenna lightning arrester unit is clearly shown in Fig. 3B. This figure also illustrates the manner of connecting a tunable coupling unit, for matching the low-impedance R.F. transmission line to the radio set, as well as for several other purposes.

Why a "tunable" coupling transformer? Well, here's the story.

### The Tunable Coupling Transformer

Any fixed coupling device is a compromise, for, the noise-reducing properties of a transmission line depends upon maintaining it in perfect electrical balance, and grounding one end of the secondary, as shown in Fig. 3A, tends to unbalance it.

The variable condenser, C, in the coupling unit illustrated in Fig. 3B, however, constitutes part of the transmission line and thus enables the operator to keep the line in perfect balance. Result: noise pick-up may be completely balanced out at all times. This balance, or matching of one side of the transmission line with the other may be secured at any time, regardless of the coupling between the transmission line and the radio set as secured by adjustment of the setting of coil L.

Greater selectivity, without loss of sensitivity, is obtained by correctly adjusting the position of the coupling coil, L. A metal shield can enclose the entire tunable coupling unit, including the lightning arresters shown in the figure.

The advantage of the tunable coupler is more apparent at the shorter wavelengths where it is most efficient. The loss which it occasions on the broadcast wavelengths may be compensated by turning up the volume control on the radio set.

While it will usually be most convenient and desirable to terminate the actual transposition line outside of the building—generally at a window very close to the receiver—there is no reason why the transposed leads cannot be continued within the house. While

the high-frequency current carried by the transmission line is not in a form which can be effectively radiated, and losses occasioned by nearby objects are less serious than those which would result in the case of an ordinary lead-in, it is desirable to take the usual precautions.

That is, keep the lead-in as far as possible from parallel flat metal surfaces such as gutters, etc. It can be braced where necessary by well-insulated guys or stand-off insulators. This is not so important, however, as with an ordinary lead-in, as swinging of the transmission line will have a negligible effect on tuning. Inside the building there is no reason why the transposed lead cannot be run flat against the wall for short distances, providing it is not near steel girders, etc.

### All-Wave, "Transposition-Cable"

(4) Doublet With Transposition-Cable Lead-in and No Impedance-Matching Transformer. Although the transposed lead-in utilizing special ceramic transposition blocks, as described in connection with Fig. 3A, is a "swell" proposition for the chap who can't sleep unless he has "the best," the antenna set-up shown in Figs. 4 and C is considerably less expensive and complicated, and will have greater appeal to "you and me."

The all-wave antenna kit illustrated in Fig. C incorporates the following units: approximately 45 ft. stranded No. 18 antenna wire; 35 ft. special twin-conductor, gum rubber covered "transposition-cable," the two leads of which are twisted, or "transposed" every 9 ins.; 3 high-quality ceramic strain insulators; 1 stand-off insulator; 2 nail-it glazed porcelain knobs, and 1 unglazed porcelain lead-in tube.

For those Service Men who are always in a hurry, the kit illustrated in Figs. 4 and C will have especially strong appeal, for it may be installed in a "jiffy." The stand-off insulator should be so positioned that the lead-in, if swayed by wind, will not rub against the side of the house or the roof. Remove about 6 ins. of the transposition-cable gum rubber covering and spread the two conductors, connecting them to the two sections of the doublet as shown in Fig. 4. Be sure to tape, first with friction tape and then with rubber tape, the open juncture of the cable bifurcation. The white lead of this cable connects to the "Ant." post of the radio set, and the black lead to "Gnd.", although in some instances it may be advisable to reverse these two connections.

It is especially interesting to note that an impedance-matching transformer is not required with this all-wave "transposition-cable" type of transposed R.F. transmission line, yet, a ground may be connected directly to the "Gnd." post of the radio set.

By resonating the antenna for most effective reception of the shorter wavelengths, generally "flat" sensitivity is obtained, in many instances. This is due to the increase in sensitivity, with an increase in wavelength of the average radio set.

### Adding An "Anti-Noise" Lead-In to the Inverted-L Antenna

(5) Inverted-L or T-Type, With Transposition-Cable Lead-In and No Impedance-Matching Transformer.

For the technician who would like to use the inverted-L type antenna discussed in connection with Fig. 2, or its companion, the T-type, but who cannot quite make the grade because of excessive local-interference pick-up by the lead-in portion of the antenna system, the arrangement shown in Fig. 5 is recommended.

This design utilizes the "transposition-cable" mentioned in connection with Fig. 4, but does so in a somewhat novel manner.

One of the two conductors in the cable is connected either to the end of the inverted-L, which points in the direction from which it is desired to receive most stations, or to the center of the T-type antenna, as shown. The unused end, and also the open juncture of the two leads should be well taped. The remaining two ends connect to the radio set and its ground connection; reverse the two transposition-cable connections to the set to determine which is best.

This "anti-noise lead-in" may be run from the flat-top, down the side of the building.

ANNOUNCING

Two NEW and BETTER Tube Testers!



Readrite  
Nos. 421-422

READRITE announces two new and better tube testers: the No. 421, for the dealer's counter—and the No. 422, a portable unit for the service man . . . out in the field. These improved testers are characterized by many unusual and outstanding features that give a new conception of tube tester performance. They are so simply designed that anyone, without experience, can operate and understand them.

These testers incorporate a 3/2" Triplet Precision Meter, which has a shaded two-color scale. It indicates in simple English that the condition of the tube is either "good" or "poor." No longer need you reassure skeptical customers as to the worth of tubes that you are testing for them.

A line voltage control A.C. meter is incorporated. Cathode and grid shorts are also tested. A simple push button provides two-plate current readings for determining the worth and conductance of all types of new and old tubes.

### Your Jobber Can Supply You

. . . with the No. 421 (counter tester) at the dealer's net price of \$24.00—and with the No. 422 (portable tester), at the dealer's net price of \$25.50. These testers come in a beautiful quarter-sawed oak case.

Readrite Meter Works

121 College Ave.

Bluffton, Ohio



SEND COUPON FOR FACTS!

READRITE METER WORKS,  
121 College Ave., Bluffton, Ohio.

Gentlemen: -

Send me a catalog on Readrite Tube Testers, and your complete line of radio servicing equipment.

Name .....

Address .....

City..... State.....

# If You Do Public Address Work

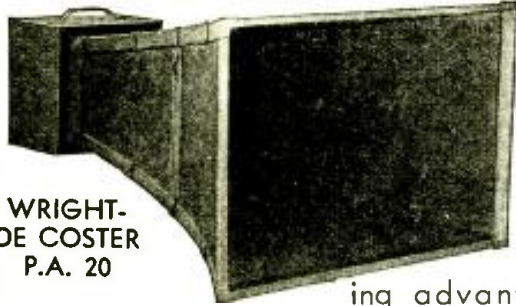

WRIGHT-  
DE COSTER  
P.A. 20

and have not yet ordered a Wright-DeCoster P.A. 20, you are not taking

advantage of the most adaptable money-making unit it is possible to have.

The unit housing is detachable from the horn and can be easily removed without the use of any tools. In this manner it can be used for indoor installation where general sound coverage is desired.

Write for literature and general information concerning the P.A. 20.

## Wright-DeCoster, Inc.

2251 University Avenue

St. Paul, Minn.

Export Dept. M. Simons & Son Co., 25 Warren St., New York

Cable Address: Simontrice, New York

Also see page 115

right through an area of strong man-made interference, and continue on to a radio set 400 or 500 ft. away, if necessary, with excellent efficiency as regards maintaining good signal strength and a high signal-to-noise ratio.

### A Combination Inverted-L and Anti-Noise Doublet Antenna System

(6) Doublet With Twisted-Pair Lead-In and Broadcast—Short-Wave Change-Over Switch. For best all-around radio reception on short waves as well as long, under average conditions in a district that is not too plentifully supplied with skyscrapers and static-producing machinery, the standard single-wire antenna, correctly installed, will give an excellent account of itself, as previously stated.

The aerial proper, exclusive of lead-in, is tuned so that it responds to the frequency ranges in which maximum sensitivity is desired. For short-wave reception this happens to be the 25 and 40 meter ranges. A length of exactly 20½ ft. for each leg of the antenna gives the correct tuning effect.

### Preventing "Noise Pick-up"

When interference is not extreme, transposition-cable may be used. Or, "in a pinch," ordinary twisted lamp cord may be used for the lead-in. However, where the interference is very great, armored-cable BX wire should be used. Cables of this type have been run for distances up to 500 ft., with practically no reduction in signal strength—by actual comparison.

It is extremely important, in most instances, to insulate the armored cable for the length of its run so that it cannot ground, but remains "floating" or unconnected to either lead or the ground.

If excessive interference pick-up is still noted, it is probable that the flat-top portion of the antenna is to blame. Consequently, it may be necessary to place the antenna on another building in order to take it out of the zone of interference, running only the shielded lead-in through this area.

A switch is shown in Fig. 6 to permit the set owner to select either a doublet antenna and transposed lead-in arrangement, for noise-free, directive, resonant reception of short wavelengths, or a type-T antenna and ground, single-conductor (equivalent) lead-in, for semi-directive and efficient reception of broadcast wavelengths.

In general, a shielded lead-in or a transmission line lead-in with transformers or coils at either end will interfere with the short-wave signal reaching the receiver.

### Versatile Antenna Connections

(7) Composite Marconi and Hertz Antenna. Continuing the tendency to simplify and combine construction elements, the modern all-wave radio set now incorporates an input terminal board that permits the use of the following antenna arrangement: (a) long inverted-L antenna; (b) short and long inverted-L antennas, and; (c) long and doublet antennas. Furthermore, the wavelength range-changing switch (in the Stromberg-Carlson Model 68 receiver and Model 69 Selector [4 tube, self-powered converter] within the set) automatically connects the correct antenna into circuit, as shown in Fig. 7.

(A) When one antenna is used for all four ranges, A and AD are connected together and to the antenna, while GD and G are connected together and to the ground.

(B) When a long antenna is used for the A and B tuning ranges and a short antenna is used for the C and D ranges, the long antenna is connected to A, the short antenna is connected to AD, while GD and G are connected together and to the ground.

(C) When a regular antenna is used for ranges A and B and a doublet or other antenna with transposed lead-in is used for the C and D ranges, the regular antenna is connected to A, the ground to G and the two leads of the transposed lead-in are connected to AD and GD.

When two antennas are installed as described above, the operation of the range switch automatically connects the proper antenna for the desired range. This is a new feature which insures the use of the best antenna at all times without thought or effort on the part of the user.

# For Sound Cars . . . . . the 608-E Amplifier



INEXPENSIVE

OPERATES  
FROM YOUR  
CAR BATTERY

- High Gain . . .
- Quality Performance . .
- No B-Batteries . . .
- No Vibrators . . .

Write for Circular

## UNITED SOUND ENGINEERING COMPANY

Manufacturers of Specialized Sound Equipment

2233 University Avenue

St. Paul, Minnesota

**Telechime**  
ELECTRIC CHIMING CALL SYSTEMS

Amplify Telechime—a real opportunity.  
Write for our special offer to radiomen.  
General Kontrolor Co., Inc.  
**DAYTON, OHIO.**

BE SURE TO READ THE ANNOUNCEMENT ABOUT THE NEW 1935 OFFICIAL RADIO SERVICE MANUAL WHICH APPEARS ON PAGE 68 OF THIS ISSUE.

By a proper switching arrangement a doublet of suitable size can be used in the latter case for both purposes. When used as the regular antenna for the A and B tuning ranges, the two leads of the transposed lead-in are connected together.

### The Effect of Different Antenna Lengths

The chart shown as Fig. 8 gives an indication of the relation of the effect of antenna length on short-wave reception. The lower horizontal axis is marked in megacycles while the upper side has the locations of the 16, 19, 25, 31 and 49 meter bands indicated (bands designated by International agreement for short-wave broadcasts, and where the majority of the stations broadcasting programs for popular entertainment are concentrated).

The vertical axis of the graph shows antenna length in feet. The unshaded areas show good antenna action for the lengths of antenna and frequencies indicated. The light shaded areas represent fair antenna action and the heavy shaded areas poor action.

As an example of the use of the chart, suppose that we are interested for the moment in the 25 meter band only. To find out what antenna lengths could be used we start along the 12 megacycle (25 meter) line and go upward until we find an unshaded area. Doing this we see that antenna lengths between 22 and 37.5 feet would give good results. Going farther we see that lengths between 60 and 78 feet would also be good. Going to still longer lengths we see that 106 to 122 feet are also indicated by unshaded area.

As this chart only applies to the type of antenna system in the Stromberg-Carlson Model 60 receiver, we are interested in seeing what lengths of antenna will be most satisfactory for the 19, 25, 31 and 49 meter bands. Therefore, we will look for an unshaded area that will include a range of antenna lengths for these four bands. From the large unshaded area at the bottom of the chart we see that a range of antenna lengths from about 25 feet to about 30 feet will be good for these four bands. Looking for longer antenna lengths (which would be more suitable for broadcast reception also) we conclude that the best would be between 100 and 165 feet. This range of lengths shows good reception on the 49 meter band, fair on the 31 and 25 meter bands and fair to good on the 19 meter band.

A study of this chart will indicate that it is desirable to have two antennas when best possible reception is desired on both broadcast and short waves. In this case a switch would be used to select the long antenna for the broadcast range and the short antenna for the short-wave range. It should be borne in mind, however, that because an antenna 55 ft. long is indicated as being poor on a wavelength of 31 meters, does not mean that it is impossible to receive stations at this wavelength. Indeed, it is often possible to receive foreign short-wave stations with a very short inside antenna or by even touching the antenna post of a sensitive receiver with a finger and allowing the body that theto serve as an antenna. It does, notice, though, that the signal-to-noise ratio will suffer and that reception of very distant and low-powered short-wave stations will not be probable.

In conclusion, we wish to extend our appreciation to the following organizations for their cooperation in the preparation of this article: General Electric Co., RCA Victor Co., Inc., Stromberg-Carlson Mfg. Co., Atwater Kent Mfg. Co., Stewart-Warner Corp., Arthur H. Lynch, Inc. and Philco Radio & Television Corp.

The writer sincerely hopes that this presentation of facts concerning new developments in all-wave antenna systems will find acceptance as a useful supplement to the rather extensive amount of theory which is generally available. ("The Antennaplex System," RADIO-CRAFT Oct., Nov. and Dec. '31; "Solving the Problems of City Aerials," Dec. '29; "Reducing Noise with Short-Wave Collectors," Sept. '32; "Reducing Man-Made Interference," and "Noise-Reducing Antenna Systems," Jan. '33.)

Fig. A, in part I, illustrates the new RCA double-doublet all-wave antenna kit. In part II, figures B and C illustrate respectively the "transposed lead-in" and "transposition cable" all-wave antenna kits manufactured by A. H. Lynch and Co.

## BOOK REVIEW

**ACTUAL TROUBLES IN COMMERCIAL RADIO RECEIVERS**, by Bertram M. Freed. Published by Service-men's Publishing Co. Size 4 x 7 ins., 180 pgs. (plus 8 blank memo. pages), 46 illustrations, paper covers. Price, \$1.00.

Written by a practical Service Man (and the first contributor, in 1929, to the Operating Notes department of RADIO-CRAFT), for practical Service Men, ACTUAL TROUBLES IN COMMERCIAL RADIO RECEIVERS points the finger of expert experience right at the probable source of trouble in more than 500 different sets of foremost radio receiver manufacturers. The volume has nothing to sell but straight-from-the-shoulder facts concerning faulty radio receiver symptoms—the items are arranged in alphabetical order for quick reference.

## REAL LIFE REPRODUCTION

(Continued from page 83)

amplifier especially constructed to reproduce very low frequencies. This amplifier is attached to the regular radio receiver through an automatic control tube, which acts, as mentioned before, as an inverted A.V.C. tube. Those who wish to try this new development will find all of the required details, as furnished by the designers for the use of English tubes, in the schematic circuit, Fig. 3.

## A GERMAN SOUND-FILM PROJECTOR

IN A recent issue of *RADIOWELT* MAGAZINE a description of a new 16 mm. sound-on-film home projector appeared. This projector, which included the actual projection apparatus, a sound reproducer, and an amplifier, all in one case, followed very closely the methods followed by American manufacturers in the design of their types of equipment. In other words, the films are perforated on one edge only, the other edge of the film being used to carry the sound track. The film is designed to run at a speed of 24 frames per second.

The appearance of this unit is shown in Fig. E. The entire unit is operated from a standard A.C. line and is designed particularly for use in small rooms. Frequencies up to 5,000 cycles are recorded on the narrow film which supplies satisfactory quality where small amplification is needed.

## A TRIPLE-BAND RECEIVER

BROADCASTING in Europe is sent on 3 separate wave bands known as long waves, intermediate waves, and short waves (this corresponds to our long, broadcast, and short waves). In order to combine in one cabinet a receiver that will cover all three of these wave bands, without limiting the efficiency of any one band, a new receiver has just been introduced on the English market. The cabinet in which this set is housed will be seen in Fig. F. It will be noticed that there are 3 dials on the slanted sections of the cabinet. Each of these 3 dials covers one wave band, and individual input circuits for each wave band feed into a common I.F. amplifier, second-detector and A.F. amplifier. The receiver itself is a superheterodyne, using an intermediate frequency of 473 kc. It also has connections for an electric phonograph pickup.

# BE AN AUTO-RADIO SPECIALIST!

**AUTO-RADIO INSTALLATION AND SERVICING**

**TABLE OF CONTENTS**

GENERAL ENGINEERING INFORMATION	Page 5-7
INSTALLATION	
Automobile Battery Grounds	8-9
Antenna Installation	10-14
Top Construction	10-14
Running Board and Under-Cat	13
Automobile Antenna Equipment	14
INTERFERENCE SUPPRESSION	15-23
SERVICE HINTS	
By Makes of Receivers and Cars	24-37
I. F. Peak Frequencies	
MISCELLANEOUS INFORMATION	
TUNES	

**FREE to you Clip coupon**

New Sylvania Auto-Radio Book contains valuable information used by radio engineers in their everyday work. Short cuts on difficult installations, handy reference data on R.M.A. Resistor Color-Code, what to do after standard suppression methods fail to eliminate ignition interference, etc.

Send for your free copy. It will help to put you in on the ground floor of the fast-growing auto-radio industry . . . a business that Sylvania engineers, themselves, actively advanced with their development of the 6.3 volt tube! HYGRADE SYLVANIA CORPORATION.

Makers of SYLVANIA TUBES, HYGRADE LAMPS, ELECTRONIC DEVICES  
© H. S. Corp., 1931

Factories EMPORIUM, PA., ST. MARY'S, PA., SALEM, MASS., CLIFTON, N. J.

**Sylvania**  
THE SET-TESTED RADIO TUBE

HYGRADE SYLVANIA CORPORATION  
Emporium, Pa. B-13

Please send free, without obligation, your new service book "Auto-Radio Installation and Servicing."

Name .....

Address .....

City..... State.....

**POWERFUL** *A New* **6 VOLT**  
**20 WATTS** **MOBILE**  
**P. A. SYSTEM**



The only powerful single unit compact Mobile Sound System built today. Operates entirely from any 6 Volt storage battery. Has phono and mike provision, with 6 Volt two-speed phono motor built in. Write for FREE description and price.

**COMPACT**  
**PORTABLE**  
**6 VOLT**  
**OPERATION**  
**BUILT-IN**  
**PHONO**  
**MIKE INPUT**

**ALLIED RADIO CORP.**  
833 W. Jackson Blvd., Dept. D.  
Chicago, Ill.

Send me FREE the following:  
 Mobile Sound Literature.  
 1934 Spring and Summer Catalog.

Name \_\_\_\_\_  
Address \_\_\_\_\_  
City \_\_\_\_\_ State \_\_\_\_\_

**Allied Radio**

**NEW VELOCITY MIKE**



Amperite Model AV. Easiest way to improve any public address system. Remarkable life-like. Flat response over entire audible range. Directional quality eliminates acoustical feedback. Write for Bulletin AV.

Assembled, list price \$25.00  
Kit, \$15.00

**NEW CONDENSER MIKE**



Professional in quality. Life-like. Special diaphragm stretched so that resonant point is far above audible range. Write for Bulletin C.

Assembled, list price \$10.00  
Kit, \$6.00

**NEW AMPERITE for 2V Tube**



A new series of Amperites. Automatically regulates filaments of tubes. Enables 2 volt set to operate on air cell, storage battery, dry cell, etc. Write for Bulletin 2V.

**AMPERITE Corporation** 561 BROADWAY NEW YORK

**SOLAR** ★

WET AND DRY ELECTROLYTIC PAPER AND MICA CONDENSERS

RECOGNIZED FOR SUPERIOR QUALITY IN ALL CLIMATES THE WORLD OVER

SOLD BY LEADING JOBBERS EVERYWHERE

**SOLAR MFG. CORP.** 599 BROADWAY NEW YORK

**BEST BY TEST!**

ASK FOR CATALOG OF EXTREMELY COMPACT TYPES HANDY FOR SERVICE

**OPERATING NOTES**

(Continued from page 93)

is of transformer-coupled push-pull type. We could not blame coupling condensers as there are none in this model. We tried shunting a 0.25-meg. resistor from one side of the secondary to ground, as shown in Fig. 3 and away went Mr. Distortion, thereby saving the price of a new input transformer, which, in these models, are very expensive due to the special type used.

**MAJESTIC 230**

No pep." was the complaint on this model. Only the locals were received. A check-up proved all voltages correct, so, consulting a schematic we found a 500 ohm resistor (not ordinarily visible) in the grid circuit of the 24 detector tube connected from grid to ground as shown in Fig. 4. As this is located inside the coil shield, alongside the coil itself, the shield must be removed before the resistor can be checked. This unit is a 1/10-W. resistor, which we found to be open. Note that replacement should be made with a 1/2-W. unit whereupon the set will perform "better as new."

**CROSLY 40S WITH DYNACONE**

Distortion," again was the complaint, and when we checked the set we found the Mershon condenser to be boiling excessively. We naturally tried new Mershon condensers, but without success in correcting the faulty operation. We then tried all other methods of distortion cure known to us—but all to no avail. Then a happy thought—we tried a new speaker. Away went distortion, and at the same time, the condenser sizzling. The trouble was in the speaker field, which would check perfectly with the ohmmeter but in operation would increase resistance and cause the symptoms mentioned. Replacing the field solved the problem.

RADIO LABORATORIES,  
Ottawa, Ont., Can.

**A MOBILE P. A. SYSTEM**

(Continued from page 92)

top of the cabinet near the phonograph motor. All plugs are polarized for fool-proof installation and operation. Two 14 in. 6 V. dynamic speakers of exceptionally sturdy construction, and equipped with 12 ft. cords terminating in plugs, are furnished with the installation. A rugged 2 button carbon microphone, 14 in. banquet stand, and 30 ft. connecting cord and plug are also supplied with the equipment.

**The New Class B 6 V. Amplifier**

The 6 V. amplifier incorporated in this sound system is of the class B type, with an output conservatively rated at 20 W. A single 76 tube is used as a voltage amplifier, feeding into a pair of 76s in push-pull as drivers. These, in turn, feed into the final stage which consists of four 79s in parallel push-push or class B. These tubes are readily accessible through a removable, ventilated panel at the rear of the cabinet.

The input is arranged for microphone and phonograph, with a 3 position switch in the center of the control panel to switch the input from "phono to "mike," or "off." The volume control, left-hand knob, is connected in the control-grid circuit of the voltage amplifier tube in such a manner that bass is not accentuated. The right-hand knob controls microphone current which is supplied by the amplifier from the 6 V. input. A single "on-off" switch, which has placed above it a ruby bull's-eye controls the entire power supply. The output tap is set at 4 ohms for parallel operation of two 8 ohm voice coils, which is the correct impedance of the speakers supplied. An additional tap is also provided at 8 ohms for the parallel operation of 2 dynamic units (horn type) which may be used if desired.

A complete high-voltage power supply delivering 250 V. of filtered D.C. to the plates of the tubes, is built in as an integral part

of the unit. This power supply consists of by the "on-off" switch on the front panel, a motor-generator which operates directly from the 6 V. source and which is controlled. It has been carefully designed and built for trouble-free, continuous service. The bearings are of the "oil-less" type, eliminating a possible source of trouble. The filter unit employed is constructed with a large margin of safety and is entirely adequate in design, using 40 mf. for filter condensers.

The phonograph, which is an integral part of the assembly, features a heavy-duty 6 V. motor designed to play either the 78 or 33 1/3 r.p.m. records. It is arranged with a speed-regulating control and a speed-changing lever. A separate "on-off" switch is employed to cut off the phonograph motor when the microphone is used. A weighted turntable is furnished, together with a 2 speed pickup of excellent quality. A bracket is provided for anchoring the pickup when it is not in use.

**Methods of Mounting Speakers**

As outlined above, 2 sturdy, 14 in. 6 V. dynamic speakers are supplied with the system. For mobile operation, they may be mounted in the rear windows of a car, and against suitable baffles, or they may be housed in a trunk carried at the rear of the car. An alternative method of installation is to mount the speakers in attractive, well-baffled cases which may be clamped to the running boards of the car or fastened on the roof. For truck use, the speakers may be mounted directly on the side panels of the truck, or on top of the truck, employing suitable baffle horns for directional effect. Aluminum trumpets with dynamic units may be arranged for maximum coverage by mounting a cluster of three facing forward, with a single horn facing to the rear, on top of the truck.

**A DE LUXE 4 TUBE SHORT-WAVE SET**

(Continued from page 92)

tivity and selectivity of an ordinary broadcast receiver to such an extent that their combined operation will actually equal, and in some cases out-perform, many expensive short-wave and all-wave receivers.

The essential difference between this converter and the conventional type is that it performs three important functions, all of which are prime requisites for short-wave reception on broadcast receivers.

A brief review of these functions will clearly indicate why such a device, and not the broadcast receiver is an important factor in the overall performance of the combination.

The fixed-tune I.F. stage (545 kc.) employed in this deluxe converter is a feature of paramount importance for the following reasons: first, because it adds an additional high-gain stage to the receiving system and thereby increases its overall sensitivity; second, because a fixed-tune stage can readily be designed for maximum amplification and more effective suppression (rejection) of undesired adjacent frequencies; and third, because the use of a pre-tuned I.F. output stage will enable the user to easily "resonate" the input circuits of the set to the tuned output of the converter (by tuning the broadcast receiver for "peak" volume).

When matched resonance is thus established, maximum transfer of energy takes place from the converter to the receiver, and perfect tracking of the oscillator is assured for the entire series of short-wave bands.

**Coil Changing Systems**

A few words regarding the relative merits of switching arrangements and plug-in coils might not be out of place.

The use of plug-in coils, although conceded to be good design, is not always the best choice. First, because some improvised method for holding the coil is nearly always used, such as a socket and prong arrangement. (It should be borne in mind that the tube socket contacts were primarily designed for use with tubes which are rarely withdrawn from and inserted into their respective sockets). Such receptacles lack a



number of important characteristics which are necessary for a perfect plug-in system. Plug-in coils are also usually unprotected from mechanical injury. It being, of course, known that the handling of exposed coil windings invariably produces a detrimental change of inductance by some slight shifting of the wires or accidental abrasion. This may greatly impair the performance of any short-wave device.

Switching arrangements on the other hand, although free from the evils associated with plug-in coils, and extremely convenient, are nevertheless characterized by a number of losses usually inherent in switch contacts, such as noise, objectionable stray capacity of the switch and its associated wiring, as well as the "dead-end" effects of unused turns or other coupling losses introduced by "idle coils."

### Tuning Circuit Features

The difficulty of tuning in short-wave stations has been effectively eliminated by carefully co-ordinating the capacitative and inductive relationship of the tuning system.

In order to produce a high R.F. voltage in the control-grid of the first-detector a high L to C ratio is employed, that is, a large inductance and small capacity are used in preference to a small inductance and large capacity. This favorable condition is brought about by using space-wound coils utilizing solid, enamel covered copper wire together with a 2 gang 140 mmf., tuning condenser.

In order to further increase the voltage on the grid of the first-detector tube, the input antenna "loading" is kept unusually low.

Loose inductive coupling is used in preference to capacitative coupling so as to eliminate the introduction of any capacitative losses in the first-detector control-grid circuit.

Four coils are used to cover the short-wave spectrum in the following steps:

- Coil "A" 13 to 30 meters (23,000 to 9,994 kc.)
- Coil "B" 28 to 60 meters (10,710 to 4,997 kc.)
- Coil "C" 57 to 130 meters (5,260 to 2,300 kc.)
- Coil "D" 120 to 299 meters (2,499 to 1,030 kc.)

It will be noted that each coil has an approximate frequency ratio of 2:3, which provides for broad separation of congested bands so as to greatly simplify the process of tuning as well as the problem of accurate oscillator tracking over the entire tuning range.

### The Circuit

The circuit of this converter is shown in Fig. 1. It will be noted that it is appreciably different from the usual run of converter circuits, particularly in respect to the use of a separate oscillator and tetrode first-detector, as well as the inclusion of a high-gain I.F. stage.

Good engineering principles were adhered to when it was decided to use two separate tubes for the combined first-detector and high-frequency oscillator, principally because separating the two functions provides for greater oscillator stability. In most pentagrid converter circuits employing one multi-purpose tube for frequency inversion and

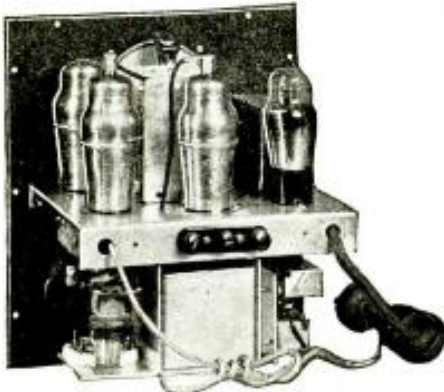

Fig. B  
Chassis view of 4 tube converter.

## Replaces "B" Cells on 90% of 500,000 Auto Radio Sets

Multi-Tap "B" supplies smooth, quiet, constant "B" power output voltage for auto and motor boat radios. Makes them permanently "modern" Gives 90 V., 135 V., 180 V., or 220 V., at various taps on connecting block shown in illustration.

The General full-wave Vibrator has over-sized contacts insuring long life. Vibrator assembly self-contained and housed in low-resistivity, non-magnetic metal case. No liability of mechanical injury or springs coming out of adjustment.

Inner vibrator case floated and completely enclosed by sound absorbing sponge rubber container within shielding metal case. Free from annoying hum and R.F. disturbances. Output entirely filtered to eliminate interference and feed-back.

All parts and wiring mounted securely direct on chassis, housed in steel, cadmium-plated cabinet. Easily installed.

### ALWAYS READY

With the Multi-tap "B" there are no dead "B" batteries left worry about when turning on the radio—full voltage is always there when turning the radio switch.

Multi-tap "B" for use with 12 V., 24 V., or 32 V. D.C. isolated lighting plants may also be had.

**SERVICE ENGINEERS—DISTRIBUTORS**  
This field is now ripe for big profits. Let's Go!

WRITE TODAY FOR ALL DETAILS

**GENERAL TRANSFORMER CORP.**

504 S. THROOP ST. CHICAGO, ILL.



"Multi-Tap"

(Trade Mark)

"B" POWER SUPPLY UNIT

(Pat. Applied for)

ONE MODEL

(Tube or Tubeless)

Operates from the 6 volt storage battery. Drains only 4.0 amperes at maximum output.

## PUBLIC ADDRESS

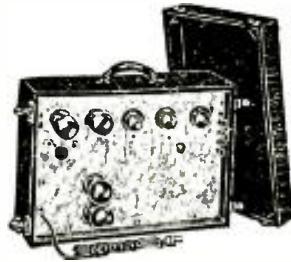

Amplifier



Duo-Speaker Unit—Opened

### Complete—Nothing Else To Buy!!!

A Real Portable Hi-Gain Amplifier System in Beautifully Finished Leatherette Cases.

**COMPLETE** WITH HEAVY DUTY BROADCAST TYPE 2-BUTTON MICROPHONE AND SATIN NICKEL FINISHED 12 POUND FLOOR STAND.

100 Feet heavy rubber cable, complete set of tubes and 2 heavy duty dynamic speakers. POWER OUTPUT 15 WATTS. BEAUTIFUL QUALITY

Coverage up to 6,000, indoors. USES 7 of the NEW TYPE TUBES  
Specially Designed for Orchestras and Solo Work. In Use by the Finest Orchestras.

SPECIAL NET PRICE **\$129.70**

F.O.B. NEW YORK CITY. 25% With Order, Balance C.O.D.

Send 3c for 1934 Catalogue

RADIO AMPLIFIER LABORATORIES, 291 E. 137th Street, New York City, N. Y.

## 5 NEW SHORT WAVE RECEIVERS in KIT FORM

It brings you the first and only complete line of Short Wave Receivers in all of Radio! Now your every requirement may be filled, for the Universal Mascot Line consists of a 1-tube battery operated set for beginners; a 2-tube battery set which performs like a "3"; a 3-tube A.C. operated set giving loud speaker reception; a 4-tube A.C. set of extreme stability and amazing power; a 5-tube set for the "died in the wool" S.W. Enthusiast. All sets (some in kit form) are licensed under RCA and Hazeltine patents and incorporate every latest improvement in circuits and tubes. Get our new, free descriptive literature which gives complete details, prices and discounts of the entire line. Address Dept. C-84.

**INSULINE CORP. OF AMERICA**  
23-25 PARK PLACE NEW YORK, N.Y.

## The All-Electric 3 SHORT WAVE RECEIVER

Greatest value on the market. Uses 6F7-1V tubes in special circuit as screen-grid regenerative detector, audio amplifier, rectifier and complete built-in power supply. Operates directly from 110 V. A.C. or D.C. Sensitive and free from hum. Range 15-200 meters. Coils and wiring diagram included. Mounted on heavy black crackle finish chassis and panel. Foreign reception guaranteed.

Kit assembled, \$5.95 Wired and tested, extra, \$1.25  
Tubes, extra, \$1.80.

**EILEN RADIO LABORATORIES**  
24 West 20th St., Dept. RC, New York City

# HOW TO BUILD, TEST AND REPAIR RADIO SETS



## Radio Construction Library

Including Television, Short-Wave Receivers and Auto Radios. 3 Volumes, 6x9—1177 pages, 561 illustrations. This practical Library includes: PRACTICAL RADIO—The fundamental principles of radio, presented in an understandable manner. Illustrated with working diagrams. PRACTICAL RADIO CONSTRUCTION AND REPAIR—Methods of locating trouble and reception faults and making workmanlike repairs. Discusses modern Short-Wave Receivers and Installation of automobile radios fully. RADIO RECEIVING TUBES—Principles underlying the operation of all vacuum tubes and their use in reception, remote control and precision measurements. Helps you to understand modern type receiving sets—full of construction data and practical links for the experimenter—a training course for service men.

10 Days' Free Examination  
Easy Terms

McGRAW-HILL

### FREE EXAMINATION COUPON

McGRAW-HILL BOOK COMPANY, INC.,  
330 W. 42nd St., New York.

Gentlemen:—Send me the new RADIO CONSTRUCTION LIBRARY, all charges prepaid, for 10 days' Free Examination. If satisfactory I will send \$1.50 in 10 days, and \$2.00 a month until \$7.50 has been paid. If not wanted I will return the books.

Name .....

Home Address .....

City and State .....

Position .....

Name of Company.....RC-8-34



RADOLEK CO., 140 Canal Station, Chicago

I am a Dealer ; Serviceman   
I operate from Shop or Store ; Home   
I own the following Test Equipment .....

My training and experience is .....

Name .....

Address .....

City .....

State .....

**RADOLEK · CHICAGO**

## 10 WATTS of RESISTOR PERFECTION

Efficient—and low-priced!

Wire - wound, vitreous - enameled, and has non-corrosive Monel metal contacts and lugs. Same type in 3 sizes, 3 ratings and 67 values.

Write for New Catalog "RC-8"

175 Varick St., New York, N.Y.  
**ELECTRAD**

modulation or detector) the oscillator efficiency of the tube rapidly diminishes as the frequencies increase due to decrease of capacitative reactance of the input circuit. The employment of a separate triode oscillator and a separate tetrode mixer (first-detector) provides for an unusually efficient form of frequency inversion, in fact continuous and dependable reception can be maintained on the 14 meter and (approximately 20 megacycles)!

For short-wave coverage a higher I.F. is always preferable in order to avoid interlocking between the carrier frequency and the oscillator frequency. This converter employs a 545 kc. I.F. for the following reasons: first, because it is the lowest frequency bordering the broadcast band (there is no danger of any broadcast or police call signal forcing its way into I.F. amplifier and causing interference); second, because a more stable gain is possible at this frequency than at any other broadcast frequency; third, because a greater inter-channel selectivity (5.45 kc.) is available at this frequency as compared with 15 kc. selectivity at the opposite, or 1,500 kc. end of the broadcast band.

### Power Supply System

The unit is completely self-powered. The standard model operates from 110 V. A.C. power lines, and consumes less than 25 W. Its operation however is possible also with 22 or 110 V. D.C., or from 2 V. aircells, as well as 6 V. storage batteries.

### Universal Antenna Provision

Another valuable feature of great importance in this converter is the provision for use of any type of antenna, including doublet, transmission line, shielded systems and special noise-reducing antennas. Practically all former converters have one side of the antenna coil grounded, a condition which necessitated wiring alterations in order to use a doublet antenna. However, in this deluxe converter, the antenna primary is isolated from the chassis by bringing both end leads out to 2 insulated binding posts, BP1 and BP2. A third post, BP3, is connected to the chassis.

When transmission lines are used the line leads are connected to BP1 and BP2. A single-wire antenna is connected to BP1, while BP2 is grounded to BP3. If a special noise-reducing antenna and its coupling transformers are employed, the output of the transformer may be treated as a transmission line or single-wire aerial (depending upon the best results obtained by comparative tests).

## CONVERTING OLD RECEIVERS

(Continued from page 89)

concerning this type of tube, transformer coupling to the 56 A.F. amplifier produced considerably better results in both volume and tone over the highly recommended resistance coupling.

The finished job finds the receiver, for some unknown reason, quite a bit more sensitive than it was prior to the revamping operation. The apparent selectivity suffers somewhat as a result of the A.V.C. action. However, the actual selectivity is found to be entirely satisfactory.

Altogether, the results are such as to convince the writer that any reasonably good receiver of 1929, or later vintage, can be very satisfactorily and economically revamped in this manner. However, there is offered merely as a good starting point for a bit of experimenting in capacitance and resistances before the best results are obtained. Therefore, the diagram herewith is offered merely as a good starting point for this work and not as cut and dried formula which will be effective on any and all sets.

And one parting hint: be sure to shield the 2A6 tube and the control-grid lead thereto, as this baby has a strong tendency to generate a lovely 120 cycle hum.

JAMES H. SLEDD

## A.V.C. IN WESTINGHOUSE WR77, RCA 80, 82, ETC.

I HAVE had six classes to remodel for A.V.C. in the above models. It seems that the customers who happen to own this type set usually know what radio performance means and they all get tired of having to get up constantly and turn the volume up or down, and can be sold very easily on a remodeling job. The procedure, in conjunction with Fig. 3, is a very simple one: first unsolder the wires from the second-detector socket, and then replace it with a G prong wafer-type socket, soldering the filament wires onto the new socket; solder the same plate wire back on the socket, but remove the .0024-mf. condenser that was connected from plate to cathode of the 27 tube, as this tends to cut down the high-frequency response of the set. Next, connect the green wire that was the grid wire on the 27 tube, to one of the diode plates. Solder a 2,500 ohm resistor from cathode to ground, and you can use the original bypass condenser, but a 5 mf. electrolytic gives a higher bass-note volume level. When the volume control is turned off, connect a .5-meg. resistor from the other diode plate to ground, and solder a 100 mmf. condenser from this plate to the plate of the 24 last I.F. socket. You are now ready to start on the coils beginning with the last I.F. coil; disconnect the grid return wire from ground and solder to one end of a .2-meg. resistor; the other side of the resistor now goes to the cathode of the 55 tube; bypass this yellow wire (grid-return lead) with a 100 to 500 mmf. condenser. Remove the 500 ohm resistor that is mounted under the dial (on a bakelite strip); also remove all its connecting wires and solder a .05-meg., ½-W. resistor in its place. Connect one side of this resistor to the grid-return wire of the last I.F. coil, and the other side of this resistor connects to one terminal of a .02-mf. condenser; the other terminal of this condenser goes to the "high" side of the new .5-meg. volume control which can now be mounted in place of the old one. (Just remove the wires from this old control and solder both of them to the chassis). Ground the opposite side of the new volume control and run a wire from the arm of the volume control to the grid cap of the 55 tube. Bore a hole beside the socket for this wire to go through the chassis). There is no change to be made in the second I.F. coil, but there is a change to be made in the first I.F. coil. Open up this coil by removing the shield and you will find that the grid-return of this coil is soldered to the chassis; unsolder it and connect the lead to the yellow wire that goes to one side of the secondary trimmer condenser of this same coil. Now, remove the yellow grid-return wire and connect another wire from here to one side of a .5 meg., ½-W. resistor; the other side of this resistor goes to the diode plate on the 55 tube that now has a condenser soldered to it (from diode plate to plate of the 24 tube). Solder a small-size .01- to .05-mf. condenser inside this coil from the grid-return to the ground, or to the same place the grid-return wire was soldered originally. Now replace the shield and let's go to the first R.F. coil on top of the chassis.

Unsolder the ground side of the antenna coil proper from the soldering lug and solder to the brace that holds the coil. Then remove the ground wire from this terminal (the return leads of both bandpass and R.F. grid windings now are all that connect to this lug), connect a .01- to .05-mf. bypass condenser from this lug to ground, and solder a small .1-meg., ½-W. resistor to the same lug. Bore a small hole through the chassis near this coil and run a wire through this hole from one side of the .1-meg. resistor to the same side of the .5-meg. resistor that connects to the grid-return lead of the first I.F. coil.

Now remove the wire that connects from the local-distance switch to the plate of the first-detector—and then disconnect all of the remaining wires from the local-distance switch, if you want the set to operate with a phone pickup or, if the chassis is used in the combination, then on the terminal

strip on the back of the chassis you make the following changes: terminal No. 1 goes to the ground side of the 2,000 ohm resistor in the cathode circuit of the last 24 L.F. tube (this will give better results if changed to a value of 700 ohms; there is no change otherwise on No. 1) terminal No. 2—remove the wire from terminal No. 2 and connect a wire from here to the high side of the volume control (now, when not using the phono. pickup do not short terminals 1, 2 and 3 together as formerly, but just use a single wire and connect from 1 to 3). Terminal No. 3—no change; terminal No. 4—no change; terminal No. 5—remove all wires and leave open. Now on the combination, disconnect the yellow with green tracer wire that goes from the "mike" input transformer terminal No. 4 to the switch terminal No. 4, give the set a good tune up and set is now ready for delivery.

The set works better with a 35 tube in the first R.F. and first L.F. sockets; although it is possible to use the original tubes, try both and use your own judgment.

H. L. CHANEY

## A 2 TUBE S.-W. CONVERTER

(Continued from page 90)

cannot possibly tune in short-wave stations (200 meters and below), naturally either a change in the design of the coils and condensers employed, or else an attachment or "converter," is necessary.

### 2 Tube Converter

The unit to be described is a self-powered job, operating from 110 V. A.C. or D.C. It employs two tubes, namely a 6A7 (composite first-detector and oscillator) and a 37 whose grid and plate are connected together (at the socket terminals) for half-wave rectification. The output of this tube is suitably filtered and employed for plate and screen-grid voltages necessary to the 6A7.

Two plug-in coils are all that are necessary to cover the useful bands within 200 to 20 meters. The brown coil permits reception from 200 to 60 meters; the black coil, 60 to 20 meters.

All values of the various parts employed in this converter are indicated in the wiring diagram shown in Fig. 1. The layout and location of each individual component is shown in Fig. A.

### Operation

The following procedure should be employed in connecting and operating the converter:

Disconnect the antenna wire from the binding post of the radio receiver and connect it to the antenna (green wire) clip lead of the converter.

Connect the set antenna (red) wire of the converter to the antenna post of the radio receiver, and set ground (blue) wire of the converter to the ground post of radio receiver. Do not disconnect ground connection from radio receiver.

After these connections have been made, uncoil the extension cord and plug it into a 110 V. A.C. or D.C. outlet.

Turn the right-hand switch to the "Broadcast" position. This disconnects the converter and connects the radio receiver for regular broadcast reception. Turn on the radio receiver and set its tuning dial to approximately 1000 kc. or 300 meters, or as close to this point as freedom from broadcast interference will permit.

Turn the right-hand switch to the "Short-wave" position and the converter is ready for tuning in short-wave stations.

If the converter is used with one of the ultra-small midget A.C.-D.C. receivers, the set ground wire need not be connected.

In some cases the local broadcast station may interfere with the reception of short waves. When this occurs, a simple wave-trap consisting of an inductance that has 20 turns of No. 20 D.C.C. wire wound on a 2 in. form, and shunted with a variable condenser of from 700 to 1,200 mmf., should be inserted in series with the antenna lead-in. Simply rotate the dial of this tuning condenser until a point is reached where the interference "fades" out.

## LATEST IN RADIO

(Continued from page 75)

### THE 1C6 AND 76 TUBES (No. 517)

THE 1C6 is an improved 2 V. filament type, 5 grid electron-coupled tube for use as a combined oscillator and first-detector. The inter-changing of the 1A6 with the type 1C6 is recommended only in circuits where the ballast lamp or filament series resistor can be changed to accommodate the extra .06-A. filament drain required by the 1C6. The 1C6 is designed especially for all-wave battery receivers and operates well up to 24 megacycles. Additional characteristics are as follows:

Plate V. ....	135	180
Fil. V. ....	2.0	2.0
C.-G. V. (Grid G) ....	-3.0	-3.0
S.-G. V. (Grid Gc)** ....	67.5	67.5
Anode-Grid V. (Grid Ga)...	135	180
Osc.-Grid Ohms (Grid Go)...	50,000	50,000
Plate Ma. ....	1.3	1.5
S.-G. Ma. ....	2.5	2.0
Anode-Grid Ma. ....	2.0	3.3
Osc. Grid Ma. ....	0.2	0.2
Total Cathode Ma. ....	6.5	6.7
Plate Resist., megohms. ....	0.55	0.75
Conversion Conductance, ....	300	325
Conversion Conductance* ...	4	4

\* With C.-G. V. at -14.0 V.

\*\* Less drop through 20,000 ohm resistor.

The tube prongs, looking at the base of the tube, are as follows, clockwise: F, P, Ga, Go, Gs, F; the cap is G.

The 76 is a general-purpose tube designed as a companion to the 77 and 78. In spite of the decreased current rating the characteristics and performance obtained are superior to that of the type 37. The 76 may be used to advantage in resistance-coupled amplifiers because of the increased amplification factor. Characteristics of this tube are as follows:

### Class A Amplifier

Heater V., A.C. or D.C. ....	6.3
Heater A. ....	0.3
Plate V. ....	250
C.-G. V. ....	-13.5
Plate Ma. ....	5.0
Plate Resist., Ohms ....	0.500
Mutual Conductance, micromhos ...	1,450
Amplification ....	13.8

The tube base connections are as follows (clockwise): H, P, G, K, H.

### SOURCES OF AUTO-RADIO NOISE (No. 518)

"SERVICE Engineering Bulletin 101," contains, in addition to the following information (concerning the figure below), considerable data of value to the car-radio Service Man. Send for your free copy.

(1) Spark-plug Cables: Radio interference is set up by the discharge across the spark plug points.

(2) Coil to Distributor Cable: Sparking between distributor points and rotor causes noisy reception.

(3) Low Tension Breaker to Coil: This unit may radiate strong interfering signals.

(4) Generator Commutator: Sparking brushes introduce noise in the electrical system.

(5) Horn: Armature may cause interference.

(6) Battery Circuit: Loose connections or intermittent grounds may cause interference.

(7-8) Lighting Circuit: Re-radiates interference radiated anywhere in the car.

(9-10) Electric Windshield Wiper, Electric Fan, or Hot Water Heater: Sparking at switch points and commutators causes interference.

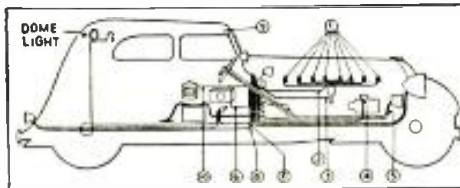

## A Radically new Tube Tester!



Model 22

This instrument tests all present day tubes AND due to use of rotary switch and variable SHUNT allows the addition of new tubes without REMOVING from case.

It tests the 2nd plate of all tubes.

DIRECT reading on shaded dial.

Allows diode and triode tests to be made separately. 3 1/4" D'Arsonval meter, 2% accuracy.

NEON leakage and short test AUTOMATIC and test for short or leakage covers all elements.

Accurate line voltage regulation allows uniform readings. Plate and filament both controlled.

AND provisions are made so that condensers .00025 to 5 M.F. can be tested for leakage-short-good. Likewise, resistance can be measured though meter scale is not calibrated for this purpose. Vacuum tube voltmeter principle is used for this test.

Portable. Top cover not shown in illustration above. Verichrome lettered bakelite panel.

Dealers and Servicemen, \$23.75  
quartered oak case, net

Dealers and Servicemen, \$22.50  
leatherette covered case

### L. & L. ELECTRIC COMPANY

Dept. 11-A

336 Madison Avenue Memphis, Tenn.

### MAIL COUPON TODAY

L. & L. ELECTRIC COMPANY Dept. 11-A  
363 Madison Avenue, Memphis, Tenn.

Enclosed you will find my remittance of \$..... for which send me, at dealers' and servicemen's net price, the MODEL 22 Tube Tester checked below:

[ ] Model 22—with quartered oak case, net \$23.75.

[ ] Model 22—leatherette covered, net \$22.50.

Name .....

Address .....

City..... State.....

## LITTLE DYNAMITE

A POWERFUL high quality amplifier yet extremely compact in size (measuring 5 x 5 x 6" high.) Has excellent response over the audio band. Especially suitable for small or portable P.A. Systems for recording and for use in conjunction with photo cells, etc. Uses a 57 high gain pentode and the dual triode 2B6 tube. An 80 tube provides humless plate supply. Overall gain 80.5 db. Will supply 1-1000 ohm field. Output 5 watts. List price, less tubes \$22.50. Dealers net \$8.95 price

Three Arcturus Tubes net \$3.15.  
Write in for free Alan Sound Handbook off the press soon.

ALAN RADIO CORP.  
83-R Cortlandt Street New York, N. Y.

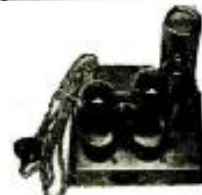

# Enjoy Your Trips WITH POSTAL Auto Radio



In achieve-  
ment of finer  
performance,

more rugged construction and improved design, the Postal Auto-Radio of six tubes, has many superb features still to be found in other models. Travel this season will be more enjoyable with the Postal Auto-Radio.

This fine receiver is powered by six tubes: 2-78's; 1-75; 1-41; 1-6A7 and 1-84, and has built-in dynamic speaker. It has remote control unit with aviation dial to make tuning easier, AVC and 20 other features.

Write for complete literature . . . and FREE attractive brochure covering essentials of auto-radio servicing.



## Postal S. W. CONVERTER



If you like thousands of other short wave enthusiasts possess a good broadcast receiver—and if you have longingly looked forward to the fascination of short wave reception—but hesitated to give up your costly broadcast receiver in purchase an expensive short wave receiver—then you should write for our free pamphlet, for it tells you how to equal, if not better the performance of the most expensive short wave receivers with your present broadcast set—without any wiring changes whatsoever. Get Your Copy Today.

any wiring changes whatsoever. Get Your Copy Today.

**POSTAL RADIO**  
135-K LIBERTY ST. NEW YORK, N.Y.

New!



## A Sales Booster for Summer P. A. Work

LEOTONE 15" AMPLITHEATRE DYNAMIC

A photophone-type dynamic speaker capable of handling up to 18 watts, undistorted and having a top "push" test of 25 watts. Ruggedly constructed, with chamois-floated, 15"-corrugated cone and Granoflex three-point outside spider. Heavy duty field, weighing alone 8 1/2 lbs. Entire weight of speaker 35 lbs. Perfect acoustic reproduction assured.

Write for Service Men's and Public Address Installers' Attractive price offer.

LEOTONE RADIO CO.

63 Dey Street

New York, N. Y.

USE

## SHURE MICROPHONES

and Related Equipment

Highest Quality . . . Low Cost

Ask your Jobber about our Latest Models



## ARE YOU GETTING THE SHURE TECHNICAL BULLETIN?

Send 6c for Sample Copy and List of Back Issues, or 50c for One-Year Subscription.

SHURE BROTHERS COMPANY

Microphone Headquarters

215 W. Heron Street

Chicago, Ill.

## A VERSATILE OSCILLATOR

(Continued from page 90)

of the short-wave band, aside from operating on the present "standard" broadcast band of 200 to 550 meters.

To facilitate reading frequency to within 500 cycles there has been developed the dial shown in the illustration. It is capable of reading to 1/10 of a division.

Figure 1 shows the circuit diagram employed for wiring the unit. The technical description of the instrument is as follows:

The signal generator uses two tubes, a 6A7 and a 37. The 37 tube acts as a rectifier in the A.C.-D.C. power supply system used.

The 6A7 tube here is employed in a very unique manner. It generates both radio and audio frequencies, the signals of which are entirely independent of one another.

When the wavelength range switch, Sw. 1, is turned "up" the calibrated curve should be read which covers the range of 105 to 500 kc. When the switch is turned "down," use the range of 500 to 3,000 kc. The R.F. oscillator circuit is of the electron-coupled type, and is capable of generating extremely powerful harmonics up to frequencies as high as 30 megacycles. Therefore the instrument can be employed to good advantage for testing and aligning short-wave receivers.

The reader will note from the diagram that the three grids connected together serve as the plate for the R.F. circuit; grid No. 4 is employed as the grid of the A.F. circuit. This "electronic" type of A.F. modulation results in a high-quality modulated signal at the output posts. Due to the variable-mu characteristics of grid No. 4, which has an inherent 40 V. cut-off bias, it becomes impossible to over-modulate the R.F. signals. The audio circuit generates a signal at 1000 cycles. This signal is helpful in aligning I.F. stages as it provides a sharp, clear note which can be easily recognized. Aside from this, the signal remains especially sharp due to the impossibility of over-modulation as mentioned above.

This A.F. signal is entirely independent of the R.F. signal, it is available at two A.F. output tip-jacks and may be employed to check speech amplifiers, condensers, etc., in field or shop work. The R.F. signal is taken directly from the plate of the 6A7 tube, which element of the tube is entirely isolated and separated from the R.F. oscillator tuning circuit. Due to this isolation the R.F. may be fed to any type of input impedance without affecting the R.F. signals generated in the R.F. oscillator circuits.

Although energy delivered at the R.F. output posts is an A.F. modulated signal, it is possible to obtain a pure C.W. signal if the A.F. output posts are shorted. Condensers C5 and C6 serve to isolate both the A.F. and R.F. circuits from the cathode. This is necessary due to the A.C.-D.C. system employed for supplying the power to the oscillator. The optimum output impedance of the A.F. circuit is 0.1-meg. ohms. Finally, resistor R2 is inserted to keep the voltage on the electron-coupled circuit low in order to allow for an ample amount of modulation as supplied by the A.F. circuit.

## NEW BOOK—BY SYLVANIA

### "AUTO-RADIO INSTALLATION AND SERVICING" (No. 519)

THIS is the title of a helpful 80 page book just issued. It's free—send us your name and address for your copy, gratis.

Following is the Table of Contents: Foreword, General Engineering Information, Installation, Interference Suppression, Service Hints, Miscellaneous Information, Tubes, Operating notes, receiver intermediate frequencies, battery grounds, and antenna data are included. Car-radio tubes are discussed as a class.

## SHORT CUTS IN RADIO

(Continued from page 95)

### REMOTE SWITCHING OF RADIO SETS

W. B. Matthews

THE convenience of being able to turn the radio set on or off from several points, may be secured by utilizing an automobile charging relay modified for use in the circuit shown in Fig. 5. The high-resistance winding is left intact for holding, and the low-resistance winding is removed and replaced by another having about 50 T. of No. 22 D.C.C. wire. This winding is energized by three dry cells in series. Midget pushbuttons are wired up, using triple-conductor annunciator wire, as shown.

The "B—" side of the high-voltage supply in the set must be opened at X, and the circuit completed through the holding winding of the relay. The two windings of the relay must be connected "aiding" to secure correct operation.

### AN EMERGENCY HUM ELIMINATOR

Chas. E. Gaskill, Jr.

DESIRING to secure emergency operation of a radio set that insisted on developing a burned-out filter choke on the Saturday night preceding a Monday holiday, the writer connected the filter circuit as shown in Fig. 6.

The circuit to the defective choke coil was bridged, as shown by the dotted line. Excessive hum then was greatly reduced by tuning the remaining choke to 120 cycles, by means of a .05-mf. condenser, C, the value of which will vary in individual instances.

### DUMONT "A" AND "B" ELIMINATOR

Herman M. Childs

READERS of RADIO-CRAFT may be interested in my "tuck" with a Dumont "A" and "B" eliminator, the schematic circuit of which is shown in Fig. 7.

There is a sheet of metal spot-welded to the front and sides, completely covering the "A" and "B" condensers and choke coils, which must be removed with heavy pliers; the condensers and chokes then may be removed by heat. The chassis is "A—"; the dry-disc rectifier is a Bonwood-Lenz unit.

The "B" choke has a D.C. resistance of about 500 ohms; the "A" choke has a very low value of resistance. The "B" voltage divider measures, from "B+", about 3,000, 2,500, and 1,500 ohms; the "A" variable resistor, R, 10 ohms. The power transformer has secondaries that deliver 5, 12, and 500 V.

### A 1 TO 15 MEGOHM "MEGGER"

C. Bradner Brown

MEGGER'S have been used by electrical engineers for locating high-resistance faults in cables and condensers for some time, but the radio profession has not readily adopted this valuable piece of testing equipment for checking units having resistance values in the range of, for example, 1 to 15 megohms.

In point-to-point tests, a condenser should indicate open-circuit providing it is not faulty; here, a "megger" would permit high values of leakage resistance to be accurately measured. Furthermore, the testing of condensers at low voltages such as is the case in the usual resistance-continuity tests may show the condenser to be satisfactory whereas in actual operating conditions, leakage may be excessive.

The megger shown in Fig. 8 is composed of a high-voltage D.C. supply and a milliammeter for the purpose of reading the current through the piece of equipment being tested.

Volume control R1 adjusts the voltage to the milliammeter and is used to prevent any change in calibration.

The resistance meter proper consists of R2, R3, and Ma., a 0-1 ma. milliammeter. A double throw single pole switch is used

to obtain a low and high range for the testing of low- and high-voltage condensers, Sw. 2 is provided.

The instrument is so arranged that the milliammeter can be used separately by plugging the external circuit into jack J2, or as a high-range voltmeter by placing R1 on zero and plugging the test leads into jack J1.

With the S.P.D.T. switch set on the "high", H, position, adjust unit R1 until the meter just reads "full-scale." The test leads which are connected to a phone plug can now be plugged into J1. The resistor or condenser to be tested is placed across the test leads and the meter reading noted. If exact values are desired, a chart can be prepared and kept handy. Such a chart, shown in Fig. 9, is easily calculated from the formula:

$$\text{Resistance under test} = \frac{\text{Fixed resistance} \times (Im - I)}{I}$$

where Im is the full-scale reading of the meter and I is the actual deflection of the needle.

To use the "low," L, scale, reduce R1 to something under half-scale and place the toggle switch in the L position (thus connecting the low-voltage resistor to the meter). The meter should then be set to full-scale reading either by shorting the test leads, or removing them from J1 and adjusting R1. The advantage of the low scale is that it allows the testing of condensers having voltage ratings under 250. The high scale must not be used for testing the usual radio receiver bypass condensers as their voltage ratings will be exceeded.

#### Uses of the Megger

The instrument has been used for some time in the service shop of a concern with which the writer has had personal contact and has proven especially valuable in the case of filter condensers. If in one case a section of a power supply filter is blown out, the other sections are apt to be greatly weakened and this fact will show up as a high leakage current which will cause a low resistance value to be obtained when tested. By the use of the megger, these weak sections can be located and removed before further trouble arises.

In some cases, leaky bypass condensers in some of the new autodyne superhot circuits will cause considerable trouble. Since the fault cannot be tested with the usual resistance meter, it is apt to go unnoticed, but with a high-resistance tester, the trouble can be readily found. A warning at this point is perhaps apropos. The resistance tester will not give reliable results when applied to electrolytic condensers. These condensers draw a leakage current at all times and the resistance will vary widely with a small change in voltage. Although some idea of the condition of the condenser can be obtained, the tests are not sufficiently accurate to warrant replacement on resistance tests only.

Paper condensers should not show much leakage, especially when used as coupling condensers. In this case, a positive voltage may be placed on the grid of the following tube which will cause distortion and may result in damage to the tube itself. The megger will locate this difficulty in a straight point-to-point test across the condenser and its associated grid leak.

Not only can condensers be measured with this instrument, but any grid leak can be readily checked. It can easily be seen that this is especially valuable when point-to-point tests are to be made.

#### List of Parts

- One Weston model 301 milliammeter, 0-1 ma., Ma.;
- One Clarostat volume control, 0.5-meg., R1;
- One Lynch resistor, .75-meg., R2;
- One Lynch resistor, .25-meg., R3;
- One power transformer, 600 V., center-tapped (and supplied with a 2.5 V. winding for the 27), P.T.;
- One filter condenser, 2 mf., 1000 V., C1;
- One I.C.A. 5 prong socket;
- One I.C.A. toggle switch, S.P.D.T., Sw.1;
- One I.C.A. toggle switch, S.P.D.T., Sw. 2;
- Two jacks, J1, J2;
- One Eveready-Raytheon ER-27 tube.

## AN IMPROVED "TREASURE LOCATOR"

(Continued from page 76)

of individuals in penal institutions. A large loop constructed around a wood frame doorway through which inmates or visitors must pass, must be substituted for the smaller loop described in this article.

(4) In searching through excavated ruins of ancient cities or villages for old metallic objects which have a historical value.

Concerning gold treasure, so much has been read of the various haunts of the pirates of generations back, that there is no determining specifically where one may turn up a treasure chest! Practically every sea-coast village from the northern-most part of New England to the southern end of Florida has its pet tale of pirate treasure buried somewhere in the vicinity. In Mexico the Aztecs supposedly buried untold wealth at the direction of Montezuma, to prevent it from falling into the hands of the Spaniard, Cortez, and his soldiers. Some of these stories may have some foundation to them and are worth investigating. The actual cost of the metal locator to be described, which will facilitate the discovery of any buried treasure, is a mere trifle compared to pleasure and excitement one may derive from what the explorer may unearth, besides the pleasure and excitement one may derive from such an exploration.

#### Principle of Operation

The metal locator consists of two units or sections, one of which is a single-tube oscillator—the circuit of which is shown in Fig. 1A—which generates a fixed audio-frequency modulated radio-frequency signal.

The inductance of the oscillator circuit is the loop that is wound around the frame of the case, which contains the oscillator equipment, as shown in Fig. 2A. The entire casing of the oscillator is movable on two wing-bolts, so that the most sensitive position may be determined before the loop is secured.

In the other section is a 5 tube receiver, the pick-up of which also depends upon a loop constructed similarly to the oscillator loop. This receiver employs 2 stages of R.F. amplification, a detector, and 1 or 2 stages (optionally) of A.F. amplification.

The purpose of the receiver is to pick up the modulated signal generated and transmitted by the oscillator.

Now, as this complete device is carried around (as shown in the photo of the complete assembly) the loop of the oscillator, which normally has a fixed inductance, varies in its inductance value when it approaches metallic deposits; this inductance value varies in direct proportion to the mass of the metal. Thus, when a variation in the note or signal is heard in the headphones it may be construed as being caused by the influence of metallic objects. After some little practice it will be easy to determine just when the locator is directly above or in very close proximity to the hidden metal.

#### Construction of the Two Units

As can be seen by reference to the schematic circuits of the oscillator and receiver, A and B, respectively, in Fig. 1, no special or highly involved apparatus are required.

Use wood construction throughout in preference to metallic sub-bases which may influence the efficiency. All values and dimensions necessary are indicated on the diagrams. Layout and constructional details are shown in at A and B in Fig. 2, and in Figs. A and B.

All dimensions should be strictly adhered to, although it may be necessary, because of cramped space, to employ special 45 V. "B" blocks, such as the Eveready No. 762, or its equivalent.

In connection with the transmitter, an off-on switch, not shown in the diagram of Fig. 1A, should be included in the "A—, B—" lead so that the power may be turned off when the instrument is not in use. A switch, for this purpose, is provided in the receiver, as shown in Fig. 1B.

## WRIGHT-DeCOSTER

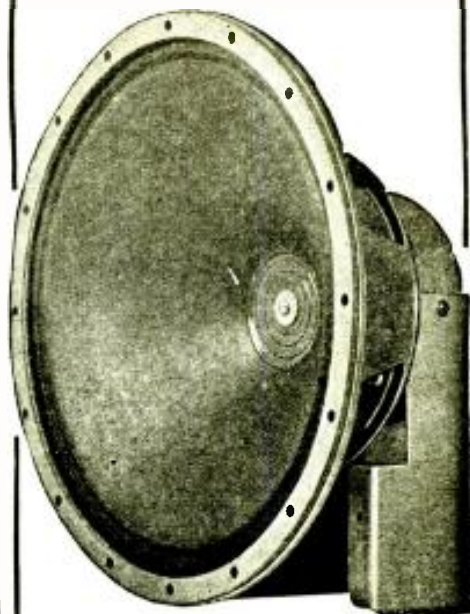

### New Model 425 Reproducer

The patented solid spider protects the air-gap against filings of all kinds. Made especially for manufacturers of high quality radio and sound instruments. The Model 425 has that rich mellow quality of tone so desirable for radios and phonographs.

Those with whom we have had the pleasure of doing business know our quality. In manufacturing this new Model at the extremely low price of \$16.50, we have not deviated one iota from our rule of manufacturing only high grade reproducers.

Outside measurement of cone bracket 1 1/8", depth 7 3/16", height overall 12 5/16".

Why not order a sample and let the reproducer speak for itself. If you are not thoroughly pleased, return the unit and your money will gladly be refunded.

**WRIGHT - DeCOSTER, Inc.**  
2251 University Avenue  
St. Paul, Minnesota

Export Dept. M. Simons & Son Co.  
25 Warren St., New York  
Cable Address: Simontrice, N. Y.  
ALSO SEE PAGE 108

The demand is  
increasing for

## WARD LEONARD RESISTORS

Progressive jobbers are  
supplying this demand

SERVICE MEN KNOW Ward Leonard resistors are dependable. The price is so low there is no profit in taking chances with overrated resistors.

Ward Leonard resistors are wire wound with silver soldered joints at the terminals. The resistance does not change. They assure quiet operation.

Write for NEW literature for service men.

**WARD LEONARD ELECTRIC CO.**  
MOUNT VERNON, N. Y.



*Dependable Sensational Performance!*

## BUD

Laboratory-Built  
P. A. Equipment

**5 DAYS FREE Trial**

Try **BUD Sound Equipment** For Five Days Absolutely Free!

ELECTRO-DYNAMIC UNITS  
CARBON AND CONDENSER  
MICROPHONES - 4 & 6 FT.  
ALL ALUMINUM TRUMPETS  
FIELD EXCITERS - AIR COLUMN  
HORNS - LOW AND HIGH  
FREQUENCY UNITS FOR WIDE  
RANGE THEATRE USE

We invite careful, critical inspection of our entire line of BUD laboratory-built sound equipment. We suggest that you conduct your own comparative test. We CHALLENGE you to duplicate BUD performance and BUD DEPENDABILITY AT ANY PRICE! Write today for descriptive literature and prices and details of our FREE FIVE DAY TRIAL offer.

**BUD SPEAKER CO.**  
1116 JACKSON ST.  
TOLEDO, OHIO - U. S. A.



### THE SET YOU HAVE ALWAYS WANTED



the "MJ" for the truly critical  
There is no finer all-wave receiver  
Write for Details  
**PIONEER SOUND LABORATORY**  
135 Liberty St. New York, N. Y.

HERE LIES  
**STATIC**  
KILLED IN ACTION BY A  
**LYNCH**  
ANTENNA SYSTEM

THIS STONE IS DEDICATED TO THE MEMORY OF THE ONLY MAN ON WHICH THIS BATTLE AGAINST THE GREATEST ENEMY TO ENJOYABLE, NOISE-FREE RADIO RECEPTION WAS WON. THE CORPUSCULED FORGERS. ITS WINNING HAS FREED ALL RADIO LISTENERS FROM DISTURBING NOISES, CRACKS, CRASHES AND OTHER NOISES.

CREATED BY  
**ARTHUR H. LYNCH, INC.** 337 FULTON ST.  
NEW YORK, N. Y.  
WRITE TO DAY FOR FULL DETAILS

Both units, Figs. A and B, are completely enclosed, the "backs" having been removed for photographing so as to illustrate the general construction of each unit.

#### Instructions for Adjustment and Use

To assemble the equipment when all the units are constructed and wired the following is the procedure.

Place the cabinets flat on the floor or on a table, and securely fasten the carrying sticks of the cabinets in position. Turn the transmitting (movable) loop at right-angles to the receiving loop (stationary). The receiving loop is carried horizontally and the transmitting loop, perpendicularly.

The apparatus is now ready for testing and this should be done as follows.

Set the instrument on a table, or on some object about 2 ft. above the ground and several feet from metal objects. Turn the switches of the transmitting and receiving loops to the "on" position. Now, insert the headphone tips into the jacks provided for them and adjust the transmitting (movable) loop until little or no signal is heard in the headphones. This position should be at right-angles to the receiving loop. (Note that this adjustment is very important as the sensitivity of the instrument depends entirely upon the completeness with which this "null point" is secured.)

Next, pass a sheet of copper (preferably), about 20 ins. square, under the receiving loop to familiarize yourself with the resulting sound. Make several adjustments of the transmitting loop until the most sensitive position is obtained. Tighten this loop securely by means of wing nuts. (If the transmitting loop varies in its proximity to the receiving loop, sound will be heard in the headphones, thus giving a false indication.)

The oscillator is of the self-modulated type, and thus it may be necessary to vary the resistance of the grid leak within the range of 3 to 7 megohms. When the correct value has been determined the instrument will start to "pop" as soon as the switch is turned on.

To operate the apparatus in the field the following instructions will be of great aid.

Carrying the instrument  $1\frac{1}{2}$  to 2 ft. above-ground, explore the "suspected" area systematically by walking back and forth in straight rows about 4 ft. apart. When the receiving loop passes over a sufficient quantity of metal a sound will immediately be heard in the headphones. The "treasure" (if any) so indicated will be located directly below the receiving loop.

Finally, attention is called to a slight modification that has been incorporated for slightly increased convenience in manipulation. Although the photograph of the receiving unit, Fig. B, shows only 4 tubes (including 1 stage of A.F. amplification), an additional tube has been incorporated in the schematic circuit, Fig. 1B, and in the part-layout illustration, Fig. 2A, to furnish a second stage of A.F. amplification. Due to the fact that this tube is operated at zero grid potential its effectiveness is apparent only on weak impulses, inasmuch as it tends to over-load on strong signals (metallic bodies close to the instrument).

#### Conclusion

The sensitivity of this unit cannot be definitely rated, but tests indicate that it is possible to obtain a signal at 15 ft. depth with a mass of metal 16 ins. square. This efficiency should prove more than sufficient for ordinary "treasure locating" work.

The best features of this instrument are its stability in field work, when properly constructed, and its simplicity in operation.

#### "SHORT WAVE TREATISE" (No. 520)

FROM "Getting Started in Short Waves," its opening chapter, to "Books for Short-Wave Fans," the closing text page, this 50 page book radiates useful information. Although primarily intended as a catalog of items dear to the heart of the short-wave enthusiast, this publication is also a short-wave primer.

Your copy is now available, gratis.

## A LONG-WAVE TUNER

(Continued from page 87)

A superheterodyne, while desirable from many standpoints, was ruled out by the difficulty of construction and aligning. Since most builders already have a broadcast set incorporating a good A.F. amplifier it was felt that the inclusion of this unit would be needless and expensive duplication.

The omission of the power pack may be open to some argument but in the interests of versatility it was decided to leave it out. As the chassis now stands it can be operated from batteries, direct from a D.C. power line or, by using any available "B" eliminator and suitable filament transformer it can be A.C. operated.

#### The Circuit

The circuit used is simplicity itself. The transformers are standard 456 kc. intermediates, with the normal tuning condensers disconnected on one side and led to a 4 pole, single-throw switch which serves to extend the tuning range by putting these condensers in parallel with the 4 gang, 350 mmf., tuning capacities, giving a maximum tuning capacity of around 450 mmf. which, with the inductances used, will serve to tune the circuit to as low as 150 kc. from a starting point just at the edge of the regular broadcast band.

The new type 6C6 and 6D6 tubes are used, which are identical in every particular with the types 57 and 58, except that the heaters are designed to operate from 6.3 volts at 3-A. With the connection block used this makes possible the operation of the filaments on 110 V. D.C. lines by connecting a resistance of 280 ohms (rated at least for 25 W.) from the terminals marked "B+" to 4, then connecting the grounded or negative side of the D.C. line to "B-" and the "high" or positive side to "B+." This will supply both heater and plate current for the set. If trouble is experienced from hum (due to the D.C. generator's commutator ripple) this may be eliminated by connecting a single-section filter (a 30 hy. choke in series with a 4 mf. or 8 mf. condenser) back to the other side of the line, on each side of the choke. In this case, however, the current for the heaters should be taken from the line side of this filter to avoid overloading the choke.

For operation on A.C. the pack supplying the plate current is connected to "B+" and "B-." Then connect "B-" 2 and 4 together; also 1 and 3 together and connect a transformer supplying 6.3 V. at 4 A. between "B-" and 1.

When using batteries this same connection holds; the "B" batteries (180 V. or more) being connected in place of the eliminator, and the 6 V. storage battery in place of the transformer.

No switch was placed in the heater line since it is difficult to place a single switch so that it will control the tubes both on series and parallel connections. However, if it is desired to incorporate a switch in the tuner, combine it with resistor R12.

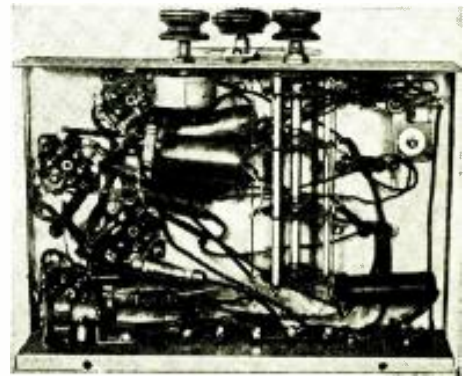

Fig. B

Underside of long-wave tuner.

The screen-grid voltage of the detector tube is quite critical and tremendous increases of sensitivity can sometimes be made by experimenting with the value of resistor R10.

Coupling to the output circuit is through the plate resistor and condenser network R11, C21. It is of course assumed that this coupling will be into the grid of an A.F. amplifier tube. It is quite possible, of course, to use a pair of headphones directly from the output tap jacks but the mismatch of impedances results in a tremendous loss of efficiency and if headphones are desired it is suggested that a battery amplifier consisting of a single, type 30 triode (or other type of low-output-impedance triode) be used simply as an impedance-matching coupler. Due to the tremendously high plate impedance of the detector tube (greater than 1.5 megohms) a transformer is out of the question for this purpose.

### Adjustments

After the wiring is completed and checked you are ready for the rather tedious operation of lining up the tuned stages. Since, while there are many stations operating in the long-wave band, the frequency of the available ones will not be known, it will be best to use an oscillator for this purpose. If a service oscillator having a continuously variable frequency from 500 kc. is not available it is a simple matter to construct one in accordance with Fig. 2. (The frequency need not be known exactly since the only purpose is to supply a signal at several points within the band to check the alignment of the tuned circuits.)

Coil L1 in Fig. 2 consists of 260 T. of No. 28 insulated wire wound on a form 3 ins. in dia. and 6 ins. long, and tapped at the center. Pick-up coil L2 should have about 50 T. on the same diameter form and mounted in such a way that the coupling between it and the oscillator coil can be varied.

Additional data concerning alignment procedure has appeared in numerous past issues of RADIO-CRAFT.

Properly constructed you will find this set sensitive and selective. The ability to secure circuit oscillation, by adjusting the volume control to maximum, permits reception of weak phone stations by the squeal method.

### Results

A listening test was conducted for a short time during one afternoon under the following conditions.

Location: Very poor, in the heart of Newark surrounded by tall, steel frame buildings and with every conceivable form of electrical interference present.

Aerial: About 50 feet long and lead-in approximately the same length, single wire and unshielded.

"B" batteries, total voltage, 250.

Headphones used only with no audio amplification.

Time: 4 P.M. to 5 P.M. (which is anywhere from 10 P.M. to midnight in various European countries).

Nothing but miscellaneous code and noise were heard for some time then a faint voice speaking in what seemed to the writer (who is, however, no linguist) to be French. Care-

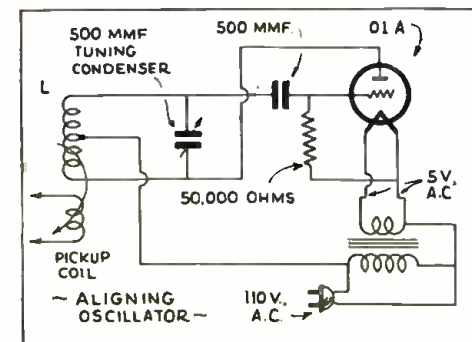

Fig. 2  
Oscillator for quick aligning.

ful listening and a check of the dial position (28) against known stations brought the conclusion that the station must be Radio Paris on 1,648 meters (182 kc.) though no announcement was heard. Since, by that time, it was growing quite late (in Europe, that is) and since the foreign stations observe more seemingly hours than the American it was decided to knock off and go at the business of picking up Europe in a serious way at some later date. A catch of one station out of the possible half-dozen or so was considered rather good the first time on the air.

For the information of those who are not familiar with European stations a list of possible catches to fish for appear on pg. 87, with other pertinent and helpful information.

### List of Parts

- Four special, high-gain, single-tuned I.F. transformers, 456 kc., L1, L2, L3, L4;
- One R.F. choke coil, 85 mh., R.F.C.;
- Three I.R.C. 1/2-W. carbon resistors, 70,000 ohms, R2, R4, R6;
- Two I.R.C. 1/2-W. carbon resistors, 25,000 ohms, R1, R3;
- One I.R.C. 1/2-W. carbon resistor, 10,000 ohms, R8;
- One I.R.C. 1/2-W. carbon resistor, .1-meg., R9;
- One I.R.C. 1/2-W. carbon resistor, .15-meg., R10;
- One I.R.C. 1/2-W. carbon resistor, .25-meg., R11;
- One I.R.C. 1 W. carbon resistor, 100 ohms, R5;
- One Electroad wire-wound volume control, 10,000 ohms, R7;
- Two Concourse dual-type paper condensers, non-inductive, .1-1-mf., 400 V., C11, C12, C13, C14;
- Three Concourse paper condensers, non-inductive, .1-mf., 400 V., C15, C16, C17;
- Two Concourse paper condensers, non-inductive, .25-mf., 400 V., C18, C20;
- One mica condenser, .001-mf., C10;
- One mica variable condenser, 80-250 mmf., C9;
- One Concourse electrolytic condenser, 25 V., 10 mf., C19;
- One 4 gang tuning condenser, 350 mmf. each section, C1, C2, C3, C4;
- Four I.C.A. 6 hole wafer sockets;
- Four I.C.A. glove-type tube shields (for tubes having size ST12 bulbs);
- One I.C.A. electro alloy chassis, 6 1/2 x 10 x 2 ins.;
- One I.C.A. spring binding post assembly, marked "ANT." "GRD.";
- One I.C.A. twin tip-jack strip;
- One 4 pole, double-throw switch;
- Three Sylvania type 6D6 vacuum tubes, V1, V2, V3;
- One Sylvania type 6C6 vacuum tube, V4.

## READERS' DEPARTMENT

(Continued from page 98)

### "LONG-WAVE CONVERTER"

EDITOR, RADIO-CRAFT:

After having constructed the "Long-Wave Converter" described in the April, 1931 issue of RADIO-CRAFT and having had such fine results with it, I thought that possibly you would like to hear from someone who has had real results with it. I constructed the converter around a Hartley oscillator circuit in the original construction.

I have not kept a complete log of stations received, using the converter in conjunction with a Majestic 52 superheterodyne. However, I will give you a listing of a few of the stations I have received but not verified: Paris, France (1,931 meters); FL, 1,446 meters; Hilversum, Holland, 1,875 meters; Hanover, Germany (at intervals) relaying Hamburg on 566 meters; and numerous experimental, weather, ship-to-shore, etc., transmissions here in the States. I have been unable to try any real DX of the past 2 years since where I am we did not have electricity and I did not find it convenient to construct a battery set. But, now, we will have a line "out our way" and I shall again be on the hunt for long-distance records.



## "Don't use all the steam for the whistle!"

We could easily build so gosh-darn much D.C. resistance into our suppressors that you could not hear a Tesla coil exploding in your gas tank. . . .

But you wouldn't get any power either. It's a case of knowing just the exact ratio of R.F. to D.C. resistance.

. . . and boy—CENTRALABS have the answer.

Central Radio Laboratories  
MILWAUKEE, WIS.

Centralab  
MOTOR RADIO NOISE SUPPRESSORS



## The New Supreme Precision Multiwave Signal Generator MODEL 180

The performance and price of Model 180 will amaze you. WRITE FOR COMPLETE INFORMATION TODAY, to

Supreme Instruments Corp.  
499 Supreme Bldg. Greenwood, Miss.

# FREE!

## Choice of One or More of These Popular Short Wave Books

Here's money put right into your pocket—here's a saving you never gave a thought to. You get absolutely FREE any one or more of the regular 25c and 50c short wave books with a year's subscription to SHORT WAVE CRAFT, the Radio Experimenter's Magazine. A one year's subscription brings you one fifty cent book or two twenty-five cent books; a two-year subscription brings you two fifty cent books and any one twenty-five cent book. Decide NOW what books are most necessary to you—then send us your subscription by return mail. The books will be sent to you immediately.



No. 1 50c No. 2 50c No. 3 25c No. 4 25c

THIS popular short-wave magazine interests the great army of "hams," broadcast listeners, and general radio students who are interested in experimental as well as scientific angles of short wave development and application. In each monthly issue appears the largest and most correct short-wave station call list, and important construction articles on receivers and transmitters, including "picturized" diagrams easily understood by anyone, a big feature "originated" by SHORT WAVE CRAFT. You'll also find the latest news about short-wave physics, micro- and ultra-short waves and other applications of this newest branch of radio.

### Many Short Wave Sets to Build

Many excellent short-wave sets with complete construction details with "picture" diagrams, are found in every issue—these sets vary from simple one- and two-tube sets to those of more advanced design, five and eight tubes.

### Big Silver Trophy FREE!

Recently inaugurated by Mr. Hugo Gernsback, Editor, was the "Short Wave Scout Contest." To the Short-Wave "fan" who has logged and obtained verification of the largest number of short-wave stations from all over the world, during one month, will be awarded a magnificent silver Short Wave Scout Trophy.

25c The Copy

4-Color Cover 9" x 12" — Over 200 Illustrations



On All Newsstands

SHORT WAVE CRAFT, Dept. RC-834  
99 Hudson St., New York, N. Y.

Gentlemen: Enclosed you will find my remittance for a subscription to SHORT WAVE CRAFT for  
[ ] One Year @ \$2.50 (Canadian and foreign \$3.00)  
[ ] Two Years @ \$5.00 (Canadian and foreign \$6.00)  
Send me FREE books which are circled below.

1 2 3 4

Name .....

Address .....

City .....State .....

(Send remittance in check or money order. Register letter if it contains cash or unused U. S. Postage Stamps.)

MAIL COUPON TODAY

If it is possible, would you please send me a diagram for a real long-wave receiver, using a bandpass filter and the new tubes, either the principle you used in the converter or the superheterodyne principle. (I would prefer plug-in coils, the use of honeycomb coils will be O.K. too, if they are the same size as the ones used in the converter).

A. L. SEALE,  
Route 3, Box 3101,  
Pensacola, Fla.

There is considerable interest in the direct reception of long-wave stations, and we shall be glad to receive reports of results obtained by radio men everywhere, with either the "Long-Wave Converter" to which Mr. Seale refers, or the long-wave tuner described in this issue of RADIO-CRAFT.

## A COMPLETE SET TESTER

(Continued from page 91)

sistance, 0/1,000/10,000 ohms/0.1- /1.0 meg-ohm, and; capacity, 0/0.125- /1.25/12.5 mf.

### The "English-reading" Tube Tester

(1) The use of the English-reading meter is helpful for showing a customer that there is no guess work or secret method involved in testing his tubes—when, in testing a tube, the pointer of the meter stops at the word "bad," the customer accepts the verdict without question.

An interesting feature of this tube tester is its ability to indicate short-circuited conditions between any 2 elements of any radio receiver tube, as contrasted with the usual tube tester, which will indicate short-circuits between only 2 or 3 elements. This tester will accommodate all receiving tubes, including those with 3 filament terminals, and filament or heater potential ratings of 1.5 to 30 V.

### The Service Oscillator

(2) A completely-shielded service oscillator is provided for operation from any A.C. power supply (which automatically accomplishes 100% modulation). The oscillator is tuned with a precision-type dial; the output is controlled by an attenuator (and any of the 6 A.C. potential-measuring ranges of the analyzer meter may be used for radio frequency output measurements).

Each oscillator is individually calibrated over a fundamental range of 100 to 250 kc.; the higher I.F. and broadcast frequencies, up to 1,500 kc., are provided by calibrated harmonics of the fundamental tuning range.

### The "Straight-Forward" Set Analyzer

(3) Simplicity and straight-forwardness characterize the design of the complete analyzer included in this tester. "Straight-forwardness" is a new term in analyzer design, and is used to indicate and emphasize the simplicity and ease with which the "free reference point" system of set analysis may be employed with this new test instrument. The "analyzing cable" of this tester simply extends the tube circuits to a neat-appearing and convenient panel arrangement of insulated terminals which enable direct or "straight-forward" meter connections for any desired measurement.

As a novel and valuable addition to the analyzing circuits, a "ground" connection is made through the flexible analyzing cable, similar to the conventional top cap or control-grid circuit, but including instead of the cap connection a "ground" clip at the top of the analyzing plug, and a "GROUND" terminal on the tester panel, so that the various measurements can be made on the tester panel with reference to the chassis of the radio set.

### The Multi-Range Ohmmeter

(a) A direct-reading ohmmeter, with 4 ranges, 0/1,000/10,000 ohms/0.1- /1.0 meg-ohm, is provided in connection with the analyzer meter. The 0/1.0 megohm range is available when used with an ordinary 45 V. battery, while the other ranges are actuated by a self-contained 4.5 V. flashlight battery.

The lowest division of the lowest ohmmeter range is 1 ohm, with the 35 ohm division at the center of the dial, which makes this range ideally suited for low-resistance-continuity tests.

(For those who practice "speed" in service work, it is one of the most interesting features of this application of the "free reference point" system of set analysis [described in detail in the September, 1933 issue of RADIO-CRAFT, in the article entitled, "The Design Principles of an All-Purpose Tester"] that any range, of any function, of the analyzer meter can be straight-forwardly connected into or across any circuit of a tube-socket for current, potential or resistance measurement.)

### The Capacity-Measuring Unit

(b) By utilizing power available in the radio set, in conjunction with this "portable laboratory," the professional radio man is enabled to test paper condensers for leakage, or to measure the leakage current of electrolytic condensers.

Three capacity-measuring ranges, 0/0.125- /1.25/12.5 mf., are provided for directly reading non-polarized condenser values on an evenly-divided scale of the analyzer meter, in connection with the regular A.C. power supply system.

Of exceptional interest is the fact that condenser capacity and A.C. voltage values are interpreted on the regular, evenly-divided scales used for measuring D.C. values. This feature, which was secured by special circuit design, avoids the necessity of resorting either to an "off-set" scale, or to the type of scale which, having the divisions crowded at one end of the scale, is characteristic of the usual "universal" meter.

The panel is finished in verichrome; the carrying case is provided with a detachable cover and a compartment for accessories.

Altogether, this portable set tester is an excellent example of the progress which has been made in testing apparatus.

## AN IMPROVED MAGNETIC SPEAKER

(Continued from page 91)

tion does not require any external power for field excitation, since the magnetic force, which is a pre-requisite of any speaker, is obtained from permanent magnets always employed in their construction.

### Construction

Unfortunately, some of the major drawbacks to magnetic types of loudspeakers were sufficient to influence radio set enthusiasts. Probably one of the most important was that of "chattering" on loud volume, due to the armature striking the pole pieces. However, this defect has been completely eliminated in the construction of the unit shown in Fig. A. An idea as to its rigid mechanical assembly can be seen in Fig. 1. The armature in this unit consists of a number of laminated pieces, which when built up, total a length approximately 3/4 x 1/4-in. in width. This member is rigidly fastened on one end by two copper leaves which "rock" on rocker arms fitted onto each end. The lead casting into which these rockers fit are curved purposely so as to facilitate this motion. Careful analysis of the construction of this speaker will show that armature motion is transmitted directly to the cone without the use of any levers or intermediary mechanical elements.

Two horseshoe-shaped magnets are employed, as can be seen from Fig. 1. They serve to reinforce each other so that an increase in the magnetic flux density at the air gap results, which increases the sensitivity of the unit.

The unit is completely encased to prevent dust or metal particles from entering the unit and interfering with its efficiency. The cone diameter is 8 ins., with concentric ridges impressed at various circumferences of the cone to improve its response characteristics.



## INFORMATION BUREAU

(Continued from page 96)

sion reading, with grid and plate connected together, has not been exceeded, continue to operate the filament at the 50% above normal value up to 2 hours, discarding those tubes which do not reactivate within this time limit.

### A SMALL MAGNETIZER

(273) Mr. W. A. Troxel, Warren, Ohio.

Q. I want to build an electromagnet for re-magnetizing phono, pickup and magnetic reproducer magnets. My idea is to take a round, soft-iron bar 1 in. in dia., about 1 ft. long and have it bent into a "U" shape. Over its two poles place 2 coils and connect them in series so that a north and south pole are created when this assembly is connected to a D.C. supply.

What I want to know is, the size and number of turns required for these coils. Also, whether this magnetizer can be used with a 6 V. storage battery, or a radio set "B" eliminator, or whether it requires 110 V. D.C. from a generator. I would rather have it operate from a 6 V. storage battery as there are no D.C. lines in Warren.

A. A suitable magnetizer designed along the lines suggested is shown in Fig. Q.273. A really effective magnetizer, however, would require the use of a 110 V. D.C. supply.

### AN ELECTRO-ACOUSTIC WAVEMETER

(274) Mr. Jacob Pierkopf, Collingsdale, Pennsylvania.

Q. What are the constants of the circuit shown at L in the department, "Recent Radio Developments—Illustrated," in the January, 1934 issue of RADIO-CRAFT, page 392? The manner in which this "electro-acoustic wavemeter" operates is not very clearly indicated.

A. Referring to the illustration, which is reproduced here as Fig. Q.274, coils B and L may be honeycomb units or a special A.F. transformer. Coil B is designed to match the plate impedance of V1. A range of 700 to 3,000 cycles can be covered with an inductance L of about 130 millihenries, and a Leeds and Northrup decade condenser box of 1 mf. capacity, C, to tune the wavemeter circuit to resonance.

With a 2 stage A.F. amplifier the sensitivity at 1,000 cycles per second is sufficient to produce a full-scale deflection of a  $7\frac{1}{2}$  ma. thermammeter by whistling a 1,000 cycle note with moderate intensity at a distance of 4 or 5 ft. from the microphone, M. Transformer T is a standard microphone coupling unit. The normal "A," "B," and "C" voltages are used on the tube, A, which may be a standard triode.

It may be of interest to note that this new frequency meter for sound waves in air has been developed for use in place of Helmholtz or Koenig resonators to detect sound and to determine the pitch. Even for those with well-trained ears the isolation of component frequencies in a complex sound wave is unreliable with Helmholtz or Koenig resonators. But the new electro-acoustical wavemeter, when correctly designed and constructed, constitutes a sensitive, selective, linear wavemeter circuit which can be used in analyzing complex sound waves. It also can be given directional characteristics and used as a sound detector and direction finder.

### ONE STAGE OF A.F. AMPLIFICATION

(275) Mr. Gregory Coppers, Cleveland, Ohio.

Q. I constructed a "1 tube loudspeaker set" using a type 38 tube which gave satisfactory results on locals, but I am now confronted with the problem of obtaining greater volume by the addition of an audio amplifier. As I live in a D.C. district, can you suggest a method by which I can couple the 38 regenerative detector to a 48 type tube?

A. We have had so many requests for diagrams of single-stage A.F. amplifiers that

we are reproducing in Fig. Q.275 4 fundamental circuits which all experimenters may adapt to their individual requirements. It is hoped that this set of circuits will be used in the future as a reference by all those who wish to add a stage of A.F. amplification to existing sets.

Tube types V1 and V4 may be of any desired type to match the remaining units of the set. At A and B are shown connections for, respectively, triode and pentode "direct-heater" power output tubes; tubes V3 and V1, in C and D, respectively, are also of the triode and pentode types, but of "indirect heater" design.

Normal ratings voltages may be applied as "A," "B," and "C"; or, any conveniently available voltages, within the safety limits of the tube used, may be applied to these circuits.

Control-grid or "C" bias voltage for direct heaters V1 and V2 is indicated to be supplied by a "C" battery. In the instance of indirect heaters V3 and V4, this "C" bias is more conveniently obtained, ordinarily, as the drop across a resistor in the "B" return circuit of the tube. The value of this unit, resistor R in C and D, may be determined experimentally or by reference to the table, "RADIO-CRAFT Bias Resistor Values," which appeared as RADIO SERVICE DATA SHEETS Nos. 113 and 114 in the May, 1934 issue, pages 670 and 671. This tabulation covers the requirements of practically every commercial tube; over 235 different operating conditions are considered, in connection with over 55 different types of tubes.

Although a magnetic reproducer is shown in all instances as a matter of convenience directly connected into the plate circuit of the power tube, this reproducer may be indirectly coupled through a condenser or by means of an output transformer in the manner shown in numerous past issues of RADIO-CRAFT. Or, it may be entirely replaced by a dynamic unit of either the permanent-magnet or electro-magnetic type; energy for the field coil of the magneto-dynamic reproducer may be obtained from an exciter unit (Information Bureau, RADIO-CRAFT September, 1933, page 168), or from the plate or filament circuit of the set in which it is used.

In circuits A and B the output of the radio set or device with which the amplifier is to be used connects to the .01-mf. condenser and one side of the filament. Inasmuch as the filament connection will be made automatically if the "A" supply is made common to both the external unit and V1 or V3, it will be necessary only to run the lead to the plate of the last tube in the external unit in order to secure input to the supplementary 1 tube audio frequency amplifier.

The same plate connection is made in circuits C and D. It is necessary, however, to exercise a little care in connecting the chassis lead. That is, if the supplementary A.F. amplifier is to be used in conjunction with a commercial radio set there is the possibility that this set will not have its filament and "B—" connections wired to the chassis in quite the relation shown in these two circuits.

Make certain that coupling condenser C is not shorted, leaky, or open-circuited.

Mr. Coppers' inquiry is best answered by reference to the article, "How to Build the Savil Type 748 D.C. Kit Set," RADIO-CRAFT, December 1932, pg. 338. This article discusses the design factors governing the use of the type 48 tube.

Following is a listing to be used in connection with Fig. Q.275:

#### List of Parts

- One mica- or paper-dielectric fixed condenser, .01-mf.;
- One grid leak,  $\frac{1}{2}$ -W, 0.5-meg.;
- One vacuum tube (to meet individual requirements);
- One tube socket (for tube selected);
- One bias resistor (for indirect-heater tube; select value as directed);
- One bias resistor bypass condenser (for indirect-heater tube circuit), 10 mf. (may be of electrolytic type, with negative lead connected to "B—");
- Eight binding posts (2 for battery connections, and 2 for output).

RCA makes  
aerial history!

NEW  
ALL WAVE ANTENNA

"Provides a new source of profit for the wide-awake service man"—says A. H. Prow, Pres. Phila. Radio Service Men's Association.

EVERY home with an all wave set is an immediate prospect... so get busy! Tell your customers how this remarkable new antenna brings up weak signals, cuts down man-made interference, gives more uniform response because of special "double doublet" feature. Kit of essential parts retails for \$7.00. Your installation charge extra.

Special "Dealer Demonstration" Antenna Kit, Net Price \$9.85, makes possible convincing demonstrations in your store. Connects to four receivers.

Have you seen the remarkable new RCA Full Range Test Oscillator? 90 to 25,000 K. C. Direct Reading Dial, weighs 5 pounds with batteries. Only \$29.50



WORLD WIDE

ANTENNA SYSTEM

## WEBSTER

CHICAGO

50 WATT

Class "A" Amplifier

for

Wall or Rack Mounting



Type A-66

Webster 50 watt amplifier for wall or rack mounting. Three stage-push pull 845 output, for microphone and phonograph. Output impedance 500 ohms. Special transformers furnished.

#### FOR CATALOGUE I

Let us put your name on the Webster mailing list to receive our regular bulletins.

The Webster Company

3830 WEST LAKE ST., CHICAGO, ILL.

# FREE

## 48-Page Supplement to the Auto-Radio Service Manual!

To everyone who now purchases the OFFICIAL AUTO-RADIO SERVICE MANUAL this big 48-page Supplement is issued FREE. Practically all of the latest sets, together with servicing information will be found in these new pages. The new Supplement does not increase the cost of the book to you, but gives you an Auto-Radio Service Manual that is right up-to-the-minute with service notes.

### Good Money in Servicing Auto-Radios

If you are overlooking servicing auto radios, you're missing a great deal of business. The auto-radio business had its greatest boom last summer when thousands of sets were sold. By now many of these same sets require servicing and with hundreds of them right in your own community, you can build up a good auto-radio servicing business. In a short time you can easily add 25% profit or more to your regular servicing business.

### List of Sets Covered in the Manual

Ame Radio Mfg. Co.	P. H. Mallory & Co.
Allied Radio Corp.	Melborn Radio Mfg. Co.
Atwater Kent Mfg. Co.	Montgomery Ward & Co.
Audiola Radio Co.	National Co., Inc.
Autocrat Radio Company	Nobilit-Sparks Ind., Inc.
Automatic Radio Mfg. Co.	Phico Radio & Tel. Corp.
Carter Genemotor Corp.	Pierce-Airo, Inc.
Century Radio Prods. Co.	Premier Electric Co.
Chevrolet Motor Company	Radio Chassis, Inc.
Consolidated Industries, Ltd.	RCA-Victor Co., Inc.
Crosley Radio Corp.	Sentinel Radio Corp.
Delco Appliances Corp.	Sparks-Withington Corp.
Detroit Radio Corp.	Stewart Radio & Tel. Corp.
Emerson Electric Mfg. Co.	Stewart-Warner Corp.
Fada Radio & Elec. Corp.	Stromberg-Carlson Tel. Mfg. Co.
Federated Purchaser, Inc.	Transformer Corp. of Am.
Ford-Majestic	United Amer. Bosch Corp.
Franklin Radio Corp.	United Motors Service
Galvin Mfg. Corp.	U. S. Radio & Tel. Corp.
General Electric Co.	Utah Radio Prods. Co.
General Motors Corp.	Wells-Gardner Company
A. H. Grebe & Co.	Wholesale Radio Serv. Co.
Grisby-Grumow Co.	Rudolph Wurlitzer Mfg. Co.
Chas. Hoodwin Company	Zenith Radio Corp.
International Radio Corp.	

**\$2.50**

Over 200 Pages  
Over 500 Illustration  
9 x 12 Inches  
Flexible Loose-Leaf Cover



### MAIL THIS COUPON TODAY!

GERNSBACK PUBLICATIONS, Inc. RC-834  
99 Hudson Street, New York, N. Y.  
Enclosed you will find my remittance of \$2.50 for which please send me One Copy of the 1933 OFFICIAL AUTO-RADIO SERVICE MANUAL with FREE 48-page Supplement. Send remittance in check or money order. Register letter if it contains cash or currency. WE PAY POSTAGE.

Name .....  
Address .....  
City ..... State .....

## THE P.E. CELL

(Continued from page 88)

the most common. The term photoelectric cell is generally used to designate a cell or tube in which electrons are emitted under the influence of electro-magnetic radiation—usually visible, ultra-violet, or infra-red radiation. The *photo-conductive* effect refers to devices in which light produces a change in electrical conductance. Such devices are known as photo-conductive cells of which the most common example is the selenium cell. The third classification is that of *photo-voltaic* cells of which there are the so-called electrolytic and electronic types. Such cells require no external source of voltage and have relatively low internal resistance.

### Photo-Emissive Cells

Photo-emissive cells have been made with many different types of sensitive surfaces. For use in the visible spectrum most cells have a surface of a pure or compounded alkali metal. Such surfaces must be prepared and maintained in a vacuum or an atmosphere of inert gas at low pressure. The cells generally take the form of a glass envelope within which the sensitive cathode is either deposited on the inner wall of the bulb or on a suitable plate structure. The anode is usually of considerably smaller area than the cathode and may take the form of a wire or ring which serves to collect the electron emission from the cathode. If the finished cell is highly evacuated it is known as a vacuum cell, in which the photo-electrons are the only current carriers. If the cell is filled with an inert gas at low pressure it is called a gas-filled cell, in which the primary electrons ionize the gas, resulting in a total photoelectric current of from one to 50 times as great as that in a similar vacuum cell.

Some of the principle characteristics of photo-emissive cells are shown (Figs. 1 to 8). In Fig. 1 the relative response of the various alkali metals to various wave lengths of light is shown. It will be noted that all of the alkalis are sensitive in the visible spectrum which extends approximately from 4,000 to 8,000 angstrom units. The maxima of sensitivity are found farther toward the longer wavelengths for increasing atomic weight of the alkali metals. Sodium and potassium are generally sensitized with hydrogen, which process shifts the maxima of these two alkalis slightly toward the red end. Tungsten incandescent lamps are generally used as light sources with photoelectric cells. The distribution of energy from a tungsten filament operated at 3,000° K is shown in Fig. 4. Because this source emits most of its energy in the red and infra-red, it has been desirable to produce photoelectric cells which have greater sensitivity for long wavelengths of light. Progress has been made in this direction at the Bell Telephone Laboratories as illustrated by the curves in Fig. 2.

The most generally used cell today is that known as the Cs-Cs<sub>2</sub>O-Ag or simply the caesium oxide type. The sensitive surface consists of a silver film or plate which is oxidized and upon which a carefully controlled quantity of metallic caesium is deposited. Caesium reacts with Ag<sub>2</sub>O to form an oxide of caesium with which a very thin film of metallic caesium is associated. The process is one which requires a considerable delicacy of control and manipulation but it results in cells which are many times more sensitive to red light than any heretofore produced.

A typical color sensitivity response curve of this cell is shown in Fig. 3. In the same figure is shown the color response of the human eye. In Fig. 4 is shown the response of the caesium oxide cell to the light from a tungsten filament.

Photo-emissive cells have a substantially linear current response with respect to incident light intensity as shown in Fig. 5. The output of gas-filled cells increases with applied voltage until the curve of Fig. 6 approaches a vertical line, at which point the ionization becomes self-sustaining and the cells glow. This generally reduces or destroys the sensitivity of the surface and should be avoided by maintaining the applied voltage below the maximum safe voltage given in Fig. 7. Vacuum cells, however,

## The Breakers

ON THE OCEAN FRONT

ATLANTIC CITY, N. J.

Situated directly on the Boardwalk and convenient to all Piers and Amusements

PER DAY per person	<b>\$6.00</b>	With Meals Private Bath
EUROPEAN PLAN	<b>\$3.00</b>	Private Bath

Hot and cold sea water in all baths  
Excellent Food—French Cuisine

Garage

EMANUEL E. KATZ, *Man. Director*

## Back Issues of Radio-Craft

which you might need to complete your files, can still be had at the price of 25c per copy. Send us your requirements, together with your remittance in check or money order.

RADIO-CRAFT, 99 Hudson St., N. Y. C.

## TYPEWRITER BARGAIN

New REMINGTON PORTABLE

ONLY  
**10¢**  
A DAY



TEN  
DAYS  
TRIAL

Only 10c a day buys this latest model machine. Not a used or rebuilt typewriter. A beautiful brand new regulation Remington Portable. Standard keyboard. Carrying case included free. Try it in your home or office for 10 days. If you do not agree that it is the finest Portable at any price, return it at our expense. Don't delay.

### FREE TYPEWRITER COURSE

Mail Coupon Today or Use Post Card

REMINGTON RAND INC.,  
DEPT. RC-13, BUFFALO, N. Y.

Please tell me how I can buy new Remington portable typewriter for only 10c a day. Also enclose your new catalogue.

Name .....  
Address .....

### Classified Advertisements

Advertisements in this section are inserted at the cost of twelve cents per word for each insertion—name, initials and address each count as one word. Cash should accompany all classified advertisements unless placed by a recognized advertising agency. No less than ten words are accepted. Advertising for the September 1931, issue should be received not later than July 5th.

#### A. C. GENERATOR

10 PRACTICAL AND LOW-COST CHANGES converting Dodge 12-V., Ford T. A., Chevrolet Delco 6-V. generators into 100-500-watt capacity A.C. generators, or into 32-110-V., D.C. motor or generator. Dodge is 500-W. self-exciter. All in one book illustrated with complete simplified instructions and drawings for only \$1. Autopower, 410 S. Hoyne Ave., Chicago.

#### ELECTRICAL SUPPLIES

INSULATION, WIRE, VARNISHES, SUPPLIES, etc. Send 3c stamp for bulletin. Autopower, 410 Hoyne Ave., Chicago.

#### PATENT ATTORNEY

INVENTORS—Small Ideas may have large commercial possibilities. Write immediately for free book, "How to Obtain a Patent" and "Record of Invention" form. Delays are dangerous in patent matters. Free information on how to proceed. Clarence A. O'Brien, 533-E Adams Building, Washington, D. C.



**10 HOURS**  
of Reading Pleasure

Six Stirring Stories of

### Future Science in August Issue

WONDER STORIES brings to its readers vivid, thrilling, and absorbing tales of adventure on alien planets—stories of biological monstrosities, time-travel, the future civilizations of man, and other educational science-fiction themes.

Here is the contents for August: DIMENSIONAL FATE by A. L. Burkholler, A VISIT TO VENUS by Festus Pragnell, THE RETURN OF TIME by A. Fedor and Henry Hesse, THE SENSE TWISTER by W. Vanck Nevens III, THE MEN FROM GAYLEN by E. Mantell, and ENSLAVED BRAINS by Eando Binder—plus several interesting departments. The voice of the SCIENCE FICTION LEAGUE.

SPECIAL OFFER (In U.S.A. only)—One year for \$2.00. Send check or money order.

WONDER STORIES, 99-R Hudson St., New York, N. Y.



Here's a book  
**RADIO MEN**  
refer to many  
times each day!

### A Valuable, All-round Radio Book!

HERE is one radio book that answers every conceivable question on interference. It contains 76 pages, 8 1/2 x 11 inches, check full with wiring diagrams, drawings and photographs showing where interference originates—how it is distributed, and how to eliminate it. This is a wealth of information needed by every radio listener, dealer and Service Man.

Send 50 cents in stamps or check for this book.

RADIO-CRAFT, 99 Hudson Street, New York, N. Y.

## SEXOLOGY

### THE MAGAZINE OF SEX SCIENCE

SEXOLOGY, foremost educational sex magazine, is written in simple language and can be read by every member of the family. It is instructive, enlightening—not a risqué book—contains no offensive matter.

Contains 25 important articles on Sex Science, 68 pages, with attractive two-color cover. Here are a few of the more important articles:

Editorial—"Sex Research"; Both Man and Woman in One Body (Illustrated); Vaginal Spasm—"Vaginitis"; (Illustrated); Why Are Homosexuals So? Undescended Testes—"Cryptorchidism" (Illustrated); The Illegal Abortion Racket; Abnormal Cravings of Pregnancy; Sex-Stimulating Perfumes; Quack Prestate Appliance (Illustrated); The Middle-Aged Bachelor; Sex and the New Leisure.

Get a copy of SEXOLOGY on any newsstand, or if your dealer cannot supply you, send 25c in stamps for a copy of the current issue.

SEXOLOGY, 95R Hudson St., New York, N. Y.

exhibit a saturation characteristic which is to be expected because of the absence of gas. Vacuum cells have roughly 1/5 the output of gas-filled cells but are more stable and are not critical with respect to operating voltage, as shown in Fig. 6.

The dynamic characteristics of a typical photo-emissive cell are shown in Fig. 8. A vacuum cell shows essentially uniform response over a wide range of frequencies. The gas-filled cell shows marked attenuation with increase of frequency. Furthermore, the greater the applied voltage (resulting in more gas amplification), the larger is the attenuation at high frequencies. As the frequency increases the dynamic output approaches that of a vacuum cell.

There are many other photo-emissive cells employing sensitive surfaces which are sensitive to ultra-violet light. Although their characteristics are interesting, their application at present is limited to scientific research and a very few semi-commercial applications.

### Photo-Conductive Cells

As mentioned previously, the selenium cell is the best known example of this type. (The element selenium, discovered in 1817 by Berzelius, is known as a "semi-conductor." Its light-sensitive properties were discovered by accident in 1873.) The usual form of cell consists of one or more parallel pairs of conductors which are bridged by a thin film of grey crystalline metallic selenium. Since light can penetrate but a very small depth of the metal, it is desirable to expose as large an area of the sensitive metal as possible without greatly increasing the resistance.

A common construction is a glass plate on which a gold or platinum film is deposited in the form of a grid. Half of the gold film is separated a short distance from the other half by a long zig-zag path in which the selenium is deposited. When an external voltage is applied a small current flows even when the cell is dark. When the cell is illuminated, the current rises to a considerably greater value. In general the following characteristics are observed:

- (1) The sensitivity increases with the applied voltage.
- (2) The sensitivity of very high-resistance cells is usually greater than that of low-resistance cells, i.e., the current ratio of light to dark values is larger for small values of current, namely, microamperes, than it is for higher values, namely, milliamperes.
- (3) The net increase in current due to light is proportional to the square root of the light intensity.
- (4) For rapidly fluctuating light, the current output of the cell is nearly proportional to the light intensity and inversely proportional to the frequency.

The static current response to various light intensities is shown in Fig. 9. In Fig. 10 the time rate of response is shown. The lag is apparently due to the fact that as electrons are freed within the metal some of them immediately begin to recombine in their travel to the positive electrode with positive ions. Eventually an equilibrium condition results in which the rate of liberation of electrons from selenium atoms is equal to the rate of recombination.

In Fig. 11 the dynamic response of a typical selenium cell is shown. As would be expected, the frequency response is poor, although satisfactory results in the audio range are claimed by the use of properly compensated amplifiers.

In Fig. 12, the color response of a typical selenium cell is shown. The cell is sensitive throughout the entire visible spectrum.

In the physical construction described above the light is generally incident at right-angles to the flow of current. A second type of cell has some useful properties. In this form the selenium deposited in a thin film on a metal plate and a semi-transparent metallic conductor is laid on top of the selenium. The incident light is parallel to the flow of current and the resistance of the cell is very much lower than that of the other type. Since the voltage dissipation of any selenium cell is limited to a small value, the voltage applied to these cells must be low.

Other forms of photo-conductive cells have been developed with considerable success. T. W. Case discovered the extremely red-sensitive

(Continued on page 123)

## Train Now for New RADIO Opportunities



Get Into a Line Where There's Action—Every Day—And a Payday Every Week—You Be the Boss!

**Analyzer & Resistance Tester—Latest Design—YOURS Without Extra Cost**

Right now while hundreds are looking for work where there isn't any, the radio service field can use trained men. With the proper training and the necessary equipment, you can enter this field and make a comfortable living. We include with our course this modern set analyzer and trouble shooter without any extra charge. This piece of equipment has proved to be a valuable help to our members. After a brief period of training, you can take the set analyzer out on service calls and really compete with "old timers." We show you how to wire short-wave receivers—analyze and repair all types of radio sets—and many other profitable jobs can be yours. Teaching you this interesting work is our business and we have provided ourselves with every facility to help you learn quickly and thoroughly. If you possess average intelligence and the desire to make real progress on your own merits, you will be interested.

### ACT NOW—MAIL COUPON

Start this very minute! Send for full details of our plan and free booklet that explains how easily you can now cash in on radio quickly. Don't put it off! Write today. SEND NOW!

RADIO TRAINING ASSN. of AMERICA  
Dept. R-8, 4513 Ravenswood Ave., Chicago, Ill.  
Gentlemen: Send me details of your Enrollment Plan and information on how to learn to make real money in radio quick.

Name .....

Address .....

City..... State.....

## BUILD YOUR OWN



Send for our new Catalog with the complete "Build Your Own" kit listings for world-beater All-Wave, Short Wave, and regular broadcast sets. Build our famous 2 tube "DX-er" described in the current issue of Short Wave Craft Magazine. Complete kit of quality parts costs only \$6.75 including coils. Anybody can build these simple successful sets inexpensively and get thrilling results.

## SOUND MEANS PROFITS

Sell SOUND Equipment during these summer months for big profits. There's a wonderful opportunity in our single unit compact Mobile Sound Systems for complete operation from a 6 Volt storage battery. They're described in our new catalog along with a complete line of A.C. Amplifiers and Sound Systems ranking from 4 to 50 watts in output. If you sell SOUND, you need our book.



## WORLD WIDE RADIO



Our new Catalog, which is yours FREE for the asking, lists the very latest All-Wave Superhets designed to tune 5 bands for World-Wide reception from 12 to 2540 Meters. These sensational performers are priced as low as \$30.85 complete in cabinet with tubes. Profit with our All-Wave and Dual Wave Sets. Send for our Catalog today!

## FREE CATALOG

Write for the valuable new ALLIED Catalog. It's FREE. In addition to complete SET-BUILDING, SOUND, and WORLD-WIDE SET listings, you will find radio's most complete stock of standard replacement parts and test equipment at consistently lower prices. Write Dept. D today for your Free copy.



**Allied Radio CORPORATION**  
833 W. JACKSON BLVD., CHICAGO, ILL.

# Radio Men!

**GOOD BOOKS WHICH HELP  
MAKE RADIO WORK MORE PROFITABLE**

Presented on this page are books of the RADIO-CRAFT LIBRARY SERIES—a most complete and authentic set of volumes treating individually, important divisions of radio. Each book has been designed to give radio men the opportunity to specialize in one or more of the popular branches of the industry. You will find them a real help in your work and they will contribute to your money earning capacity. Read these books during your spare time at home.

The authors of these books are well-known to everyone. Each is an expert radio man; an authority on the subject—each is thoroughly familiar with the field which he represents.

This is the first real opportunity that you have ever had to build a library of radio books that are authentic. MOST OF THE BOOKS HAVE BEEN RECENTLY REVISED AND REWRITTEN TO KEEP THEM UP TO THE MINUTE. Mail coupon below for your books.

Book No. 1  
**Radio Set Analyzers**  
And How To Use Them  
By L. VAN DER MEL

With Full Instructions and Descriptions of Set Analyzers, Tube Checkers, Oscillators, etc. (Just revised.)

Book No. 2  
**Modern Vacuum Tubes**  
And How They Work  
By ROBERT HERTZBERG

With complete Technical Data on All Standard and Many Special Tubes. (Just revised.)

Book No. 3  
**The Superheterodyne Book**

All About Superheterodynes  
By CLYDE FITCH  
How They Work, How to Build and How to Service Them.

Book No. 4  
**Modern Radio Hook-Ups**  
The Best Radio Circuits  
By R. D. WASHBURNE

A Complete Compendium of the Most Important Experimental and Custom-built Receivers.

Book No. 5  
**How to Become a Radio Service Man**  
By LOUIS MARTIN

How to get started in the business of servicing radios and how to make money in this field.

Book No. 6  
**Bringing Electric Sets Up to Date**

By CLIFFORD E. DENTON

With Pentodes, Multi-Mus, Dynamic Speakers—Complete Information How to Modernize A. C., D. C. and Battery Operated Receivers.

Book No. 7  
**Radio Kinks and Wrinkles**

By C. W. PALMER  
For Service Men and Experimenters

A Complete Compendium on the Latest Radio Short-Cuts and Money Savers—These Kinks Are Great Time-Savers.

Book No. 8  
**Radio Questions and Answers**

By R. D. WASHBURNE

A Selection of the Most Important of 5,000 Questions Submitted by Radio Men During the Course of One Year—They Are All Answered by a Technical Expert.

Book No. 9  
**Automobile Radio and Servicing**

By LOUIS MARTIN

A Complete Treatise on the Subject Covering All Phases from Installing to Servicing and Maintenance. A Book That is Greatly Needed Today. (Just Revised.)

Book No. 10  
**Home Recording and All About It**

By GEORGE J. SALIBA

A Complete Treatise on Instantaneous Recordings, Microphones, Recorders, Amplifiers, Commercial Machines, Servicing, etc.

Book No. 11  
**Point-to-Point Resistance Measurements**

By CLIFFORD E. DENTON  
The Modern Method of Servicing Radio Receivers—a Book Which Radio Service Men Have Referred to More Than Any Other.

Book No. 12  
**Public Address Installation and Service**  
By J. T. BERNSELY

Modern Methods of Servicing and Installing Public Address Equipment.

## Big Discount To You

In order to make it possible for everyone to buy these books, the fifty (50) cent price has been made uniform for all volumes. You can buy these books separately, but you should take advantage of our special offer:

**When Five (5) Books Or More Are Ordered Deduct 20% From Your Remittance**

Simply fill in the coupon at left, and mail it to us together with your remittance. Checks, stamps or money orders accepted.

Here are the subjects covered—

Set Analyzers  
Tubes  
Superheterodyne Circuits  
Radio Hook-ups  
Servicing Business  
Modernizing Electric Sets  
Kinks and Wrinkles  
Questions and Answers  
Auto-Radio Servicing  
Home Recording  
Resistance Measurements  
Public Address

### All Books Uniform

Volumes are all uniform size, 6 x 9 inches, and contain on an average of 50 to 120 illustrations. Each book is printed on fine paper and no expense has been spared to make it an outstanding value.



## CLIP—MAIL THIS COUPON TODAY!

GERNSBACK PUBLICATIONS, INC., 99 Hudson Street, New York, N. Y.

I have circled below the numbers of books in the RADIO-CRAFT LIBRARY SERIES which you are to send me, and have deducted 20% for ordering five (5) books or more. I have included my remittance in full, at the price of 50c each, when less than five books are ordered.

The amount of my remittance is..... (Stamps, checks or money orders accepted.)  
Circle numbers wanted: 1 2 3 4 5 6 7 8 9 10 11 12

Name ..... Address .....

City ..... State ..... RC-834

## THE P.E. CELL

(Continued from page 121)

characteristics of oxidized thallium sulphide. The latter serves to bridge the conductors of a grid as in the selenium cell. F. Michelson has alloyed selenium and tellurium to obtain red sensitivity.

### Photo-Voltaic Cells

Photo-voltaic cells are among the oldest of light-sensitive electrical devices. Becquerel in 1839 observed that light on one of two electrodes in an electrolyte produced an e.m.f. T. W. Case and others have developed this effect to a more or less practical degree.

Several years ago a certain radio tube Company announced their photolytic cell, which is of this type. Both of the electrodes are covered with crystalline cuprous oxide and a weak conducting electrolyte surrounds them. When one of the electrodes is illuminated a voltage appears at the terminals of the cell. The cell is unsuited for furnishing continuous current but is intended for use in sound equipment where the fluctuating light intensity produces a varying voltage. The cell is connected in series with a condenser and the primary of a step-up transformer, the secondary of which is connected to the grid of an amplifier tube.

The D.C. potential developed at the terminals of the cell is shown in Fig. 13. It is to be noted that the potential approaches a maximum value of approximately 160 millivolts beyond which an increase of light intensity produces very little rise in voltage. When it is used in sound projection, its principal merit is that it can be connected to the amplifier at some distance by means of a low-impedance line.

The frequency response claimed by the manufacturer is shown in Fig. 14. It is customary to use an amplifier which is peaked at the high end. One of the difficulties experienced in the field with this cell has been that the electrolyte leaks out of the case in time.

The color sensitivity curve of the photolytic cell is somewhat similar to that of the human eye. It is shown in Fig. 15.

Both in this country and abroad the electronic type of photo-voltaic cell has been developed and commercialized. In these cells electrons are displaced by the action of light, which results in an e.m.f. at the terminals of the cell. A typical construction consists of a metallic plate upon which is a layer of sensitive cuprous oxide or other material. On top of this layer is a semi-transparent conducting film. The metal plate and the conducting film are the two electrodes.

The electronic type of photo-voltaic cell is capable of furnishing a continuous current over a long period of time without depreciation. This cell represents a direct converter of light energy to electrical energy. No battery or other source of potential is used in the external circuit of the cell. The current output of a typical cell (Weston) is shown in Fig. 16. It will be noted that the linearity of response and magnitude of the output current is lessened as the load resistance is increased. The reason is that the internal conductance of the cell acts as a bypass for a part of the generated current and the greater the external load resistance the larger the proportion of the current which is shunted internally. Furthermore, the resistance of the cell decreases as the light intensity increases (not linearly, however), which accounts for the flattening of the response curve.

In Fig. 17 is shown the open-circuit voltage output characteristic. It is an interesting fact that if two similar cells are connected in parallel to a load circuit of resistance  $R$ , the current is twice that of one cell providing that  $R$  is small. Also, if two cells are connected with a load of resistance  $R$ , the current is approximately the same as for one cell connected to a load of  $\frac{1}{2} R$ .

The color response of this cell is shown in Fig. 18. The red sensitivity is low but the characteristic is not greatly different from that of the human eye. The frequency response is very poor due to the high shunt capacity of the two cell electrodes. By making the cells of smaller size this difficulty is reduced to some extent.

### Comparing Light-Responsive Cells

The photo-emissive cell is in most general commercial use for the following reasons:

- (1) High red sensitivity.
- (2) Stability.
- (3) High impedance resulting in large voltage signal when used with electronic amplifier tubes.
- (4) Linearity of response.
- (5) Good dynamic response.

Its principal limitations are:

- (1) It generally requires amplification in relay equipment.
- (2) It requires an operating potential of 50 V. or more.
- (3) Operating current should be limited to not more than 50 microamperes—generally less.

The advantages of the photo-conductive cell are:

- (1) Some types can be made very sensitive to infra-red light.
- (2) Some types have large current output (with low sensitivity).
- (3) Some types have high sensitivity with low current.
- (4) Can be operated at low voltage.
- (5) It has good response in all parts of the visible spectrum.

Its disadvantages are:

- (1) Some types are unstable.
- (2) It has a rather high dark current.
- (3) Its time lag is great and dynamic response is poor.
- (4) It is critical with respect to operating voltage.
- (5) It has a considerable temperature coefficient.

The advantages of the photo-voltaic cell are:

- (1) It operates without external source of voltage and is particularly suitable for portable use.
- (2) Can be used with relays without amplification if sufficient change in light intensity is available.
- (3) Two or more cells can be conveniently used in parallel or series.
- (4) Relatively large output currents can be obtained with sufficient light intensity.
- (5) Some types are stable over long periods.
- (6) Color response is similar to that of human eye.

The limitations of this type are:

- (1) Its output cannot be conveniently amplified by vacuum tube methods.
- (2) Its dynamic output is very poor.
- (3) Since the output cannot be efficiently amplified when used with relays, the relays required are of low torque (resulting in low contact pressure and relatively slow speed of operation) and are expensive.
- (4) For relay operation relatively large changes in illumination are necessary.
- (5) It has a high temperature coefficient.
- (6) Limited ambient temperature range.
- (7) It has appreciable lag of response in quantitative measurements.

### Bibliography

- Arceturus Radio Tube Co., *Photolytic Cells*; 1931.
- Barnard, *The Selenium Cell*; Richard R. Smith, Inc., N. Y., 1930.
- Campbell and Ritchie, *Photoelectric Cells*; Isaac Pitman and Sons, 1929.
- G-M Laboratories Inc., *G-M Visistrons*, Bulletin 119B, 1932.
- G-M Laboratories Inc., *Quartz Photoelectric Cell*, Bulletin 136B, 1932.
- G-M Laboratories Inc., *P. E. Cell Characteristics*, C.S. 503, 1932.
- G-M Laboratories Inc., *Operation of P. E. Cells*, Bulletin 125, 1931.
- G-M Laboratories Inc., *Operating Requirements of P. E. Cells*, Bulletin 140, 1931.
- G-M Laboratories Inc., *Type F2 Cell*, C.S. 555, 1933.
- Hughes and Dulbridge, *Photoelectric Phenomena*; McGraw-Hill, 1932.
- The Physical and Optical Societies of London, *A Discussion on Photoelectric Cells and Their Applications*, June, 1930.
- Weston Electrical Instrument Co., *The Weston Photronic Cell*, 1932.
- Zwoykin and Wilson, *Photoelectric Cells and Their Applications*, John Wiley & Sons, 1932.



Mr. E. H. Rietzke, President of CREI, former chief instructor at Naval Research Laboratory, and an outstanding figure in the Radio profession.

## "I Want to Make SERVICE ENGINEERS

out of Service Mechanics"

A "Parrot" can be taught to say certain words . . . but such a limited vocabulary won't get him very far! Most Servicemen are that way . . . they have been taught to follow diagrams . . . and without "this Bible" they are lost when they tackle an unusual job.

## If a Job "Stumps You" . . . It is Probably You and NOT the Set!

Don't follow diagrams—stop guessing! CREI can train you to go right to the source of trouble on a minute's inspection because our Service Engineers know not only WHY the equipment works, but also HOW it is built and connected. A CREI man can diagnose trouble with the same efficiency as a doctor.

## MORE JOBS—MORE MONEY!!

CREI training gives you the "tools" to make yourself a Service Engineer, if you are willing to sacrifice a few dollars and a little time to insure a definite future. Your inquiries are invited.

## ● WRITE FOR FREE CATALOG!



CAPITOL RADIO ENGINEERING INSTITUTE

14th and Park Road, Washington, D. C. Dept. RC-8

## You Should Have This 192 PAGES SHORT WAVE PUBLIC ADDRESS MANUAL



Bound in a Beautiful Red Leatherette Cover

Size 5 1/2 x 8 1/2 inches

### SPECIAL FEATURES

- \*S.W. Hoelver Construction Articles
- \*Public Address Construction Articles
- \*Transmitting Articles
- \*Efficient Aerial Installations
- \*Characteristics of Tubes
- \*Testing Equipment

Only 50¢ And Many Other Important Items Reserve Your Copy Now. Every Radio Man Will Find This Book a Veritable Book of Data Dealing with All Kinds of Radio Problems.

TRY-MO RADIO COMPANY, Inc.  
85-C Cortlandt Street, New York, N. Y.  
Send for a FREE Copy of Our P.A. Circular

## STOP GUESSING!

Radio service is easy when you know just where to look for the troubles. And, the securing of profitable rates for repairs makes the job still more attractive. A CHUCKER eliminates guess-work in "What is Wrong, and What to Charge." This trouble-localizer, with a really profitable schedule of flat rates included, enables you to localize any trouble in any radio, in a few minutes right in the field. Permits you easily to convince set owners that you are not guessing at either the trouble or the price of the repair job. Your competitor is making good money by using a CHUCKER.

Send \$1.00 NOW for yours, postpaid.

FREED'S RADID CO. (Dept. R)  
5053 Baltimore Avenue Philadelphia, Pa.

# follow the crowd — they're going "Short-Waves"

## THE OFFICIAL DOERLE Short-Wave RECEIVERS 15-200 Meters



YES, the crowds are going "wild" over short-waves; and the Doerle receivers are making them even wilder. Many have built their own and have obtained miraculous results. Others have purchased them already built and have obtained even better results. And why shouldn't they? These receivers, fundamentally, are so simple that they are absolutely fool-proof. As a result, they work ANYWHERE—not only in this country—but in any location. Day after day, night after night and with amazing regularity, they pull in stations from the far corners of the earth—REGULARLY—always on the same points of the dial.

Only parts of the highest quality, such as Hammarlund variable condensers, etc., are employed; for we fully appreciate that "a short-wave receiver is no better than the poorest part going into its construction." All fancy gadgets and embellishments have been entirely removed, only the most fundamental parts necessary for successful operation are employed. You will be impressed with their simplicity. You will be even more impressed with their operation. These receivers will convince you that foreign reception CAN be obtained—and with uncanny regularity—whenever they are on the air.

The Doerle receivers are available in two types, each type consisting of two models. The Electrified Doerle, both the 2-tube and 3-tube models were designed for those localities where electric service is available. They must be used in conjunction with a specially-designed hum-free A.C. power pack. The 2-volt battery types were designed for the rural districts. They, too, may be had in 2 and 3-tube models.

It may be possible for you to purchase similar receivers or parts for such receivers at greatly reduced prices elsewhere. We admit this at once. But unless you, too, wish to join the ranks of the disillusioned and skeptical short-wave fans you will insist upon the Official Doerle Receivers—Receivers which contain only highest quality parts. All Doerle receivers are built on beautiful, crackle-finished chassis and bear the official name-plate of the only recognized Doerle manufacturer. All 2-tube models measure 9" x 6" x 6 1/2"; 3 tube models 10 1/2" x 7" x 8".



- No. 2140 2-Tube 12,500 Mile Doerle Receiver Completely Wired and Tested. Shipping Weight 5 lbs. **YOUR PRICE \$9.88**
- No. 2142 Complete Accessories. Shipping Weight 22 lbs. **YOUR PRICE \$5.38**
- No. 2143 3-Tube Doerle Signal Gripper Completely Wired and Tested. Shipping Weight 7 lbs. **YOUR PRICE \$12.84**
- No. 2145 Complete Accessories. Shipping Weight 35 lbs. **YOUR PRICE \$7.19**
- No. 2174 Electrified 2-Tube 12,500 Mile Doerle Receiver Completely Wired and Tested. Shipping Weight 5 lbs. **YOUR PRICE \$10.44**
- No. 2176 Complete Set of Tubes for Above; Either 1-57 and 1-56 for A.C. operation or 1-77 and 1-37 for battery operation. **YOUR PRICE \$1.60**
- No. 2177 Electrified 3-Tube Doerle Signal Gripper Completely Wired and Tested. Ship. Wt. 7 lbs. **YOUR PRICE \$15.29**
- No. 2179 Complete Set of Tubes; Either 1-58; 1-57 and 1-56 for A.C. operation or 1-78; 1-77 and 1-37 for battery operation. **YOUR PRICE \$2.50**
- No. 2149 Special Hum-Free A.C. Power Pack including 80 Rectifier Tube. **YOUR PRICE \$7.25**

## Just Imagine! — 2-TUBES



in one  
GLASS BULB  
—  
that's the  
"TWINPLEX"  
15 to 200 Meters

The new type 53 tube makes possible this Twinplex "double-action" receiver. This tube actually contains 2 separate tubes in the same glass envelope. Just imagine what this means! It means that a 2-tube receiver can now be built for the price of a 1-tube set. This is exactly what has been done in the Twinplex receiver. A comparison of prices with the Doerle 2-tube receivers listed above will immediately substantiate this statement. And what's more, it actually performs like a 2-tube set. The circuit is practically the same as you will receive stations which you never knew even existed before. We have received many letters from satisfied users of the Twinplex receiver praising it to the skies. And justly so, for it is a wonderful little set. It affords full band coverage of from 15 to 200 meters, which includes the amateur bands, police and airplane calls, foreign reception and numerous code stations.

Only the finest quality parts such as Hammarlund variable condensers, Kurz Kasch high-ratio variable alkals, etc., are employed. All these parts are mounted in a beautiful, crackle-finished metal chassis which entirely does away with "hand capacity."

The receiver is universal in operation which means that it may be operated either with batteries or with an A.C. short-wave power pack. 150 volts is required for the plates of the tubes and 2 1/2 volts, either A.C. or D.C., for the filaments. For a fan who is first starting in the short wave game, the Twinplex is the most economical receiver with which to begin.

No. 2115 Twinplex "Double-Action" Short-Wave Receiver Completely Wired and Tested, including diagram but less tubes. Shipping Weight 9 lbs. **YOUR PRICE \$7.50**

### WE ISSUE NO CATALOG

All orders are F. O. B. New York. Terms: A deposit of 20% is required with every order. Balance may be paid on delivery. Deduct 2% if full amount is sent.

## FAMOUS Oscillodyne 1-TUBE WONDER SET 15-200 Meters

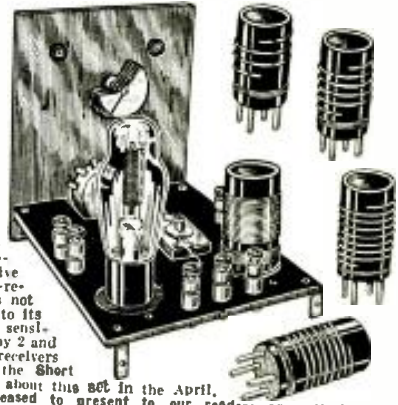

And a wonder set it is at that! Although the circuit of this unique little receiver is of the regenerative type, it acts like a super-regenerative set; yet it does not belong in that class. Due to its peculiar circuit it has the sensitivity and selectivity of many 2 and even 3-tube short-wave receivers. Read what the editor of the Short Wave Craft Magazine says about this set in the April, 1933, issue: "We are pleased to present to our readers an entirely new development in radio circuits—the Oscillodyne. This circuit which is of the regenerative variety, acts like a super-regenerative set. Its sensitivity is tremendous. The editor, in his home on Riverside Drive, New York City, in a steel apartment building, was able to listen to amateurs in the midwest, USING NO AERIAL AND NO GROUND. With the ground alone, a number of Canadian stations were easily pulled in."

Here then is a set which brings in stations thousands of miles away; a set which frequently brings in Australia, loud enough to rattle your phones and in stations several thousand miles away without aerial or ground. And the many hundreds of testimonial letters from short-wave fans who have either built their own or have purchased them, fully substantiate these remarkable results. The receiver may be used either with batteries or A.C. power pack. Requires a 237 tube for battery operation and a 227 for A.C. operation. Available either completely wired ready to use or in kit form. Four pages of detailed instructions and diagrams are included with each set. The aluminum panel 6" high x 4 1/2" wide. The bakelite base is 5 1/2" long x 4 1/2" wide. Shipping Weight 3 lbs. **YOUR PRICE \$7.20**

No. 2147 Official One-Tube Wonder Set, in kit form, with detailed construction plans. Shipping Weight 3 lbs. **YOUR PRICE \$6.35**

No. 2148 Complete Accessories, including the following: one 37 tube; set of standard headphones; four No. 6 dry cells; two 45-volt "B" batteries. Shipping Weight 22 lbs. **YOUR PRICE \$5.50**

## GRENPARK COMPANY

101 Hudson St. Dept. RC New York, N. Y.

RADIO-CRAFT for AUGUST, 1934

• Index to Advertisers •

<b>A</b>	
Aerovox Corporation	127
Alan Radio Corporation	113
Allied Radio Corporation	110, 121
Amperite Corporation	110
<b>B</b>	
The Breakers	120
Bud Speaker Company	103, 116
<b>C</b>	
Capitol Radio Engineering Institute	123
Central Radio Laboratories	117
Classified Section	121
Coast-to-Coast Radio Corp.	106
Concourse Electric Company	125
Coyne Electrical School	65
<b>D</b>	
Tobe Deutschmann Corp.	104
<b>E</b>	
Eilen Radio Laboratories	111
Electrad, Inc.	112
<b>F</b>	
Fordson Radio Co. Company	127
Freed Radio Company	123
<b>G</b>	
General Kontroler Corp.	108
General Transformer Corp.	111
Greenpark Company	124
<b>H</b>	
Hammarlund Mfg. Company	125
Harrison Radio Company	125
Hygrade-Sylvania Corp.	109
<b>I</b>	
Insulino Corp. of America	111
<b>K</b>	
Kato Engineering Company	127
<b>L</b>	
L. & L. Electric Company	113
Ward Leonard Electric Co.	115
Leotone Radio Company	114
Arthur H. Lynch, Inc.	116
<b>M</b>	
McGraw-Hill Book Company	112
Midwest Radio Corp.	102
<b>N</b>	
National Radio Institute	Back cover
National Union Radio Corp.	105
<b>P</b>	
Pioneer Sound Laboratories	116
Postal Radio Corp.	114
<b>R</b>	
Radio and Amplifier Laboratories	111
Radio City Products Company	125
Radio Trading Company	128
Radio Training Association	121
Radiolok Company	112
RCA Institutes, Inc.	106
RCA Radiotron Co., Inc.	101
RCA-Victor Company, Inc.	119
Readrite Meter Works	107
Remington Rand, Inc.	120
<b>S</b>	
S. O. S. Corp.	127
Sexology Magazine	121
Shallcross Mfg. Co.	127
Shure Brothers Company	114
Solar Mfg. Company	110
Supreme Instruments Corp.	117
<b>T</b>	
Try-Mo Radio Company, Inc.	123
<b>U</b>	
United Sound Engineering Co.	108
<b>W</b>	
Webster Company	119
Wellworth Trading Company	126
Wireless Egert Engineering, Inc.	106
Wright-DeCoster, Inc.	115, 108

(While every precaution is taken to insure accuracy, we cannot guarantee against the possibility of an occasional change or omission in the preparation of this index.)

## A 5-TUBE PORTABLE

(Continued from page 79)

regulating resistor is the usual filament supply for 2 V. tubes. Suppose we are using four 30s and one 31 or their equivalent, Fig. 3A. If we use four dry cells (in series-parallel, of course, instead of two, the battery life will be more than doubled, because of the lower discharge rate per cell. Reconnecting the tubes in two parallel groups and the four dry cells in series, Fig. 3B, will give the same life, but it will be noted that 2 V. excess initial voltage must be dissipated in the resistor. Since this seems excessive, suppose we reduce the number of dry cells to three, Fig. 3C. This will reduce the battery life to about 75% of that of the arrangement using four cells, but the cost will be reduced a similar amount and there is one less dry cell to carry around.

Choice of "B" batteries will depend on space and weight limitations.

### Sensitivity and Selectivity

A simple T.R.F. circuit is adequate for the reception of local stations in a metropolitan area, but where real performance is desired a superheterodyne circuit employing a pentagrid converter tube is the logical choice.

Referring to the circuit diagram in Fig. 2, it will be noted that a Sparton 25-S tube, the only 2 V. duo-diode triode tube available, is used as the second-detector. Owing to its inefficiency, diode detection is not used, rather the triode portion is used as detector, and the diode plates used only for A.V.C.

### Volume and Quality

The thousands of midget sets that have been sold is evidence that there is entertainment value for most people in a radio that does not have the highest possible fidelity of reproduction, so if our portable is deficient in this respect we need not be too greatly chagrined. The very lowest notes will be missing—for it takes considerable power, a fairly heavy dynamic reproducer, and large baffle area to properly reproduce the bass frequencies, and these conditions can not be met very well in a portable.

The pentode is probably the most satisfactory output tube for the portable set, because of its high power sensitivity, high efficiency, and simple circuit requirements.

### The Portable Receiver

The sides of the carrying case, which is homemade, are made of 1/8-in. tempered presd-wood and are securely fastened with long thin screws to the top and bottom, which are of wood 5/16-in. thick. Inside dimensions of the case are 10 x 11 x 6 1/2 in. deep. Cross pieces, on which the chassis rests, are fastened in the middle of the front and back, and stop strips for the front panels and back cover put in. The outside of the case is covered with artificial leather, a handle fastened to the top, and four rubber "feet" to the bottom. The loop antenna, which is the front cover, is made of 1/4-in. wooden strips as shown in Fig. A, with the wire wound in saw slots in the cross pieces. It is covered on each side with light, stiff cardboard, and in addition the outside and edges covered with artificial leather. The back is a heavier piece of cardboard covered on one side with artificial leather. The two front panels are also made of presdwood; the lower

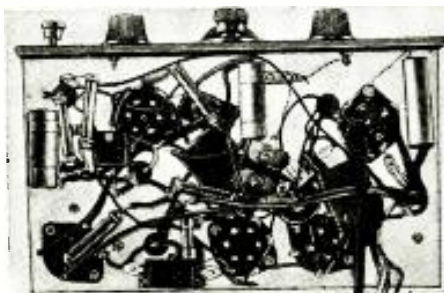

Fig. D  
Underside of 5 tube portable.

RCP • RCP • RCP • RCP • RCP

## Build Your Own TESTER & ANALYZER

Save \$\$\$

Complete  
KIT  
Only  
\$1475



Equip for busy fall and winter during summer spare time. Model 303A DEPENDABLE TUBE TESTER is perpetually up-to-date. Tests all of today's tubes—more than 130 types—and provides for 50 more new ones. Highest grade D'Arsonval type moving coil meter—quicker, more accurate. Only two selector switches. Has short tester, pilot light indicator, gas test, second plate for all rectifiers, line voltage adjustment. Handsome leatherette case. Etched panel. Completely assembled and wired, if desired, \$18.75.

**Other Kits** MULTITESTER No. 403. Thoroughly efficient, modernly equipped for all future needs. 3-range ohmmeter, 1-range volt meter. Also microammeter. Kit \$10.95. Complete \$14.95.

SUPER TEST UNIT No. 500. Designed for connection to MULTITESTER or to bring your present analyzer up-to-date. Has every feature you'll want for years to come. Kit \$10.85. Complete \$13.85.

ANALYZER No. 5400. Combines MULTITESTER and SUPER TEST UNIT in one compact, deluxe instrument every service man will be proud to own. Kit \$26. Complete \$34.50.

Write for free Wiring Diagrams and Data Sheets

**RADIO CITY PRODUCTS CO.**

48 WEST BROADWAY, Dept. RC-8, NEW YORK, N. Y.

RCP • RCP • RCP • RCP • RCP

## Build for PERMANENCE

For efficient short-wave receivers and transmitters of lasting quality, use the world-famous Hammarlund Condensers, Coils, Chokes, Sockets and Shields. Backed by 33 years of engineering leadership.

Write for new FREE CATALOG "RC-8"

HAMMARLUND MFG. CO.  
424-438 West 33d Street  
NEW YORK CITY

For Better Radio  
**Hammarlund**  
PRECISION  
PRODUCTS

### Specified Parts for the PRACTICAL ALL-WAVE LINE NOISE FILTER

as described Page 28, July RADIO-CRAFT

FOUNDATION KIT

4—Polymet .0055 Mica Condensers  
5—Special Duo-lateral Coils  
1—Triunier Condenser

\$2.75

### World Wide 2-Tube Short Wave Receiver

12,500 MHO reception record established! Wave-length range 15 to 625 meters. Get foreign broadcasts, police calls, airplanes, amateurs, etc. DIRECT! Complete KIT (no drilling) with clear instructions to build this remarkable receiver.

\$4.75



Send \$1.00. Balance C.O.D. Results Guaranteed!

NOT a toy or an attachment! A REAL, complete all-wave receiver!

ORDER NOW! Or send for free literature.  
HARRISON RADIO COMPANY  
142 Liberty St. Dept. R-8 New York City

## CONCOURSE

Dry Electrolytic  
Wax Paper

"Pee-wee" Paper Tubular

CONDENSERS

389-409 WALES AVENUE, NEW YORK  
Write for 1934 Catalog

# BARGAINS

All Merchandise Offered On Page  
Is Absolutely New And Unused

HERE IS A GREAT VALUE!

## Electrical Portable Sprayer Outfit

**\$27<sup>50</sup>**  
COMPLETE

Formerly sold for \$68.50

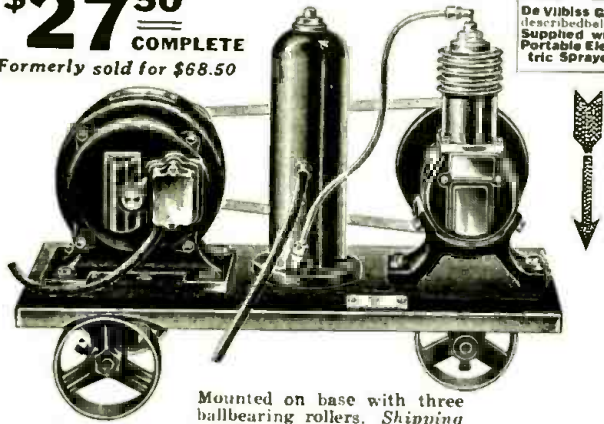

De Vilbiss Gun (described below) Supplied with Portable Electric Sprayer

Mounted on base with three ballbearing rollers. Shipping weight of complete outfit, 55 lbs.

This is the ideal outfit for all-around spraying work wherever current is available. With this electric sprayer you can spray paint, varnish, duc, enamel, lacquer, insecticides, etc., with speed. You can move it from one room to another with ease. Simply insert plug into electric socket and this marvelous machine is ready to do a man-size job—and do it efficiently.

This electric portable sprayer saves its cost over and over again on your own work. It will make money for you doing jobs for others.

Outfit equipped complete with De Vilbiss Gun, Universal head, with quart aluminum cup, which enables you to obtain round or fan spray.  $\frac{1}{2}$  H.P. heavy duty motor, 110-volt, 60-cycle, AC air filter, safety valve, Kellogg Air-Cooled Compressor,  $1\frac{1}{2} \times 1\frac{3}{4}$ , 15 feet of hose, cord and plug. Pint mason jars can be used on gun for extra containers.

Price of complete outfit with gun, \$27.50  
Price of outfit without motor, \$20.00

## De Vilbiss Spray Gun

**\$5<sup>95</sup>**



Big Bargain

A fast suction-feed attached cup spray gun for use with low pressure compressing units of small displacement. Operates from 20 to 50 lbs. Pressure, produces fan spray 5" in width. Tip adjustable for either round or flat spray. Material flow control, will spray lacquer, enamel, paint, varnish, and duc. Produces smooth, even finish, displacement 2 cu. ft. per minute, equipped with aluminum quart cup. Pint glass mason jar can be used for extra container.

Shipping weight, 3 lbs.

## Filter Tank \$4<sup>25</sup>

Complete with tank, gauge and 60 lb. safety valve

Compressed air filter and expansion tank, equipped with gauge and safety valve. Has standard taps in tank and base ready to install. Eliminates oil and moisture.

Same as illustrated in Electric Portable Sprayer Outfit shown above.

Shipping weight, 7 lbs.

## Kellogg Air-Cooled Compressors at less than half price!

Same as illustrated in Electric Portable Sprayer Outfit shown above.

Size	Maximum Pressure	Speed	Motor	Price
$1\frac{3}{4} \times 1\frac{1}{2}$	75 lbs.	600	$\frac{1}{4}$ H.P.	<b>\$7.50</b>
$1\frac{1}{2} \times 2$	100 lbs.	600	$\frac{1}{4}$ H.P.	<b>9.00</b>
$2 \times 2$	125 lbs.	600	$\frac{1}{3}$ H.P.	<b>10.50</b>
$2\frac{1}{2} \times 2$	175 lbs.	500	$\frac{1}{3}$ H.P.	<b>12.50</b>

Shipping weight, 12, 13, 14, and 18 lbs.

BARGAIN PRICE ON

## G. E. Motors

These Motors were manufactured by the General Electric Company and originally intended for use by a large manufacturing company. Since they were not used, we are enabled to offer them at an unusually low price.

Here are the specifications: 1/30 H.P.—4800 R.P.M. Universal A.C. and D.C. 110 volts—instant reverse. Size: Diameter 3 inches, length 5 inches.

Shipping weight, 3 lbs.

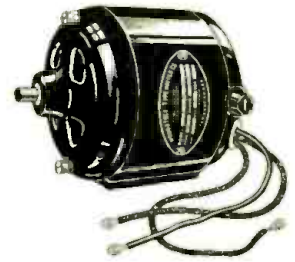

Original Price \$12.00

**\$2<sup>45</sup>**  
Each

Add 25c for packing and shipping charges to any point in U. S. A.

WHILE THEY LAST

## Westinghouse

### Power Generator

Manufactured by the Westinghouse for U. S. Signal Corps. Ballbearing Rotor, case dimensions  $4\frac{1}{2} \times 6\frac{1}{4}$  diam. Guaranteed new and perfect.

Shipping weight, 13 lbs.



While They Last!  
**\$4<sup>95</sup>**

Here is what one of our customers writes:

"These generators are being used in a small fishing village, where the only current is supplied from a 2K.W.-D.C. generator.

As it was impossible to use A.C. sets and especially my short wave transmitter using two '45 tubes, one of the generators is used to supply my two A.C. receivers and the other to supply power for the transmitter. Both generators are run by a  $\frac{1}{2}$  horsepower D.C. motor. These generators perform perfectly and have been absolutely trouble free. The voltage and current regulation is remarkably stable, taking a considerable overload."

(Name supplied on request)

## G. E. Phonograph Motor

Absolutely Brand NEW!

Variable speed induction type self-starting, 110 volt, 60 cycle, AC, with lever control. Speed range from 6 to 200 RPM. Can be installed in place of old-fashioned, hand-winding speed motor. Also ideal for display turn table, and a hundred other uses. These G.E. Electric Motors are brand new, in original factory cartons. Same motor that formerly sold for \$15.00. **\$3<sup>95</sup>** only

Shipping weight, 11 lbs.

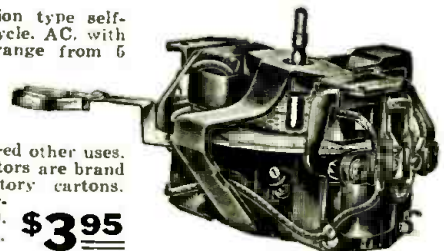

Formerly Sold for \$15.00

WELLWORTH TRADING CO.  
560 West Washington St., Chicago, Ill.

RC-834

I enclose \$..... for which please send me the following:

Name.....  
Address..... City..... State.....

## ORDER

## FROM THIS PAGE

Since We Do Not Publish Any Catalog

Remit by check or money order for full amount of each item—shipped by express if sufficient money is not enclosed to ship by parcel post. No C.O.D. order accepted. Money refunded if not satisfied. Be sure to state shipping point if express or freight office is not in your town.

WELLWORTH TRADING CO.

560 West Washington St.

Chicago, Ill.



## A 5-TUBE PORTABLE

(Continued from page 125)

one, to which the speaker is fastened, measures  $5\frac{1}{2} \times 10$  in., the upper one is just enough smaller to enable it to slide easily in and out of the case. The chassis is made of  $1/32$ -in. aluminum, and measures  $5\frac{1}{2} \times 9\frac{1}{2} \times \frac{1}{2}$  in. high.

Referring to the control panel, in the lower left corner is the on-off switch Sw. 1, above that the three tip-jacks for the loop connections, and in the upper corner is the filament resistor shorting switch Sw. 2. In the upper right corner is the A.V.C. switch Sw. 3, and in the lower corner the phone jack. On either side of the tuning dial are, above, the two volume controls R1 and R2, and below, the two regeneration controls C10 and C11.

The tube filaments are connected as in Fig. 3C. Instead of using a rheostat, switch Sw. 2 is used to short out resistor R10 after about 50 hours of operation to compensate for the decreased "A" battery voltage. If desired, R10 may be replaced by a 1 or 2 ohm resistor, and Sw. 2 dispensed with.

In determining the correct number of turns on the loop, the temporary hookup in Fig. 1 was used. With the 1AG tube circuit oscillating, the heterodyne note of an unmodulated oscillator could be heard in the phones. Then the number of turns across C1 was adjusted to properly cover the broadcast band, with sufficient additional turns to cause the tube circuit to oscillate with C10 set near maximum. Since tuning the oscillator circuit of a converter tube does not react on the control-grid circuit, this same calibration holds in making the tracking adjustments. This loop consists of 30 T. of No. 24 D.C. C. wire, tapped at the 22nd turn, the outside turn going to the control-grid. The oscillator coil consists of 70 T. of No. 32 enameled wire wound on a 1 in. form. A couple of thicknesses of paper are wrapped over the ground end, and over this the plate (anode grid) coil, consisting of 35 T. of the same size wire, is wound.

### Adjustments

When regeneration is used, a little more attention must be paid to proper shielding and filtering. However, since it was not desired to load the chassis with unnecessary bypass condensers, a little experimenting was done to determine where they were necessary. It was found necessary to isolate the screen-grid of V1. This is done with a small R.F. choke instead of a resistor to avoid reducing the screen-grid voltage. Since V4 draws its plate current through R9, it acts as a bleeder resistance, helping to regulate the screen-grid

voltage. Choke R.F.C. 2 is quite necessary for stable operation. Condenser C14 determines the amount of energy fed back through C11. If too small, the circuit of V3 may oscillate continuously, if too large, little or no regeneration will be obtained. Its value is determined by experiment. It was found necessary to shield the exposed control-grid lead to V2. This is done by slipping a short length of braided copper shielding over the insulated lead.

No trimmer is used across C3. Its approximate value is determined by experiment, and the final tracking adjustment made with the I.F.T. trimmers. It will be seen that shifting the I.F. slightly has the same effect as varying C3. C2A is used to adjust the tracking at the high-frequency end as usual. Since varying C10 and C11 affects the peaking of the I.F. transformers, they must all be adjusted together.

With C10 and C11 set near minimum, the I.F. transformers are tentatively aligned at the correct frequency for proper tracking. Then a station or modulated oscillator in the broadcast band is tuned in and C10 and C11 advanced until maximum regeneration is obtained in both circuits without oscillation anywhere in the broadcast band, at the same time keeping the I.F. transformers in alignment. The regeneration condensers are not touched when tuning in most stations, but are advanced slightly when a little extra selectivity and sensitivity are needed.

### List of Parts

- One 2 gang condenser, 350 mmf. per section, C1, C2;
- One trimmer condenser, 35 mmf., C2A, (not needed if there are trimmers on tuning condenser);
- Two panel mounting compression type variable mica condensers (Crosley "Intensifiers"), 85 mmf., C10, C11;
- One mica condenser, 500 mmf., C3;
- Three mica condensers, 250 mmf., C4, C12, C13;
- One mica condenser, .001-mf., C14;
- One midget paper condenser, .005-mf., 500 V., C15;
- Two dual paper condensers, .1-mf. per section, 200 V., C5, C6, C7, C8;
- Two paper condensers, .1-mf., 200 V., C9, C16;
- One electrolytic condenser, 5 mf., 25 V., C17;
- One dual paper condenser, .5-mf. per section, 200 V., C18, C19;
- One oscillator coil;
- One I.F. transformer, double tuned, 465 kc., I.F.T. 1;
- One I.F. transformer, double tuned, center-tapped secondary, 465 kc., I.F.T. 2;
- One A.F. transformer;
- One volume control potentiometer, 1000 ohms, R1;
- One volume control potentiometer, .5-meg., R2;
- Three carbon resistors, .1-meg., 1 W., R3, R5, R8;
- One carbon resistor, 50,000 ohms, 1 W., R4;
- One carbon resistor, 2 meg.,  $\frac{1}{2}$  W., R6;
- One carbon resistor, .5-meg., 1 W., R7;
- One carbon resistor, 10,000 ohms, 1 W., R9;
- One wire-wound resistor, 4 ohms, R10;
- One R.F. choke, about 3 mhy., R.F.C. 1;
- One R.F. choke, about 10 mhy., R.F.C. 2;
- Three battery switches, Sw.1, Sw.2, Sw.3;
- One 5 spring, filament control type, phone jack;
- Two 6 prong wafer sockets, for V1, V3;
- Two 4 prong wafer sockets, for V2, V4;
- One 5 prong wafer socket, for V5;
- Three tube shields, for V1, V2, V3;
- one 1AG tube, V1;
- One 34 tube, V2;
- One 25-S tube, V3;
- One 30 tube, V4;
- One 950 tube V5;
- One 5 in. magnetic reproducer;
- One vernier dial;
- Four knobs;
- Three tip-jacks;
- Three dry cells, "A" battery;
- Four  $22\frac{1}{2}$  V. "B" batteries,  $4 \times 2\frac{1}{4} \times 2\frac{1}{2}$  ins.;
- One carrying case, with loop built into front cover, and panels and aluminum chassis as described in text;
- Miscellaneous hardware, screws, rubber grommets, short length of braided shielding, and hook-up wire.

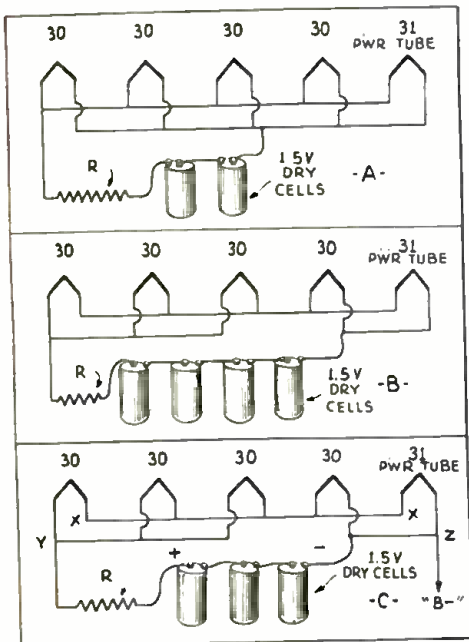

Fig. 3

Optional "A" battery connections.

## BUILD YOUR OWN SHALLCROSS UNIVERSAL TESTER

For \$41.50 Complete



VOLTS  
A.C.-D.C.  
5-25-100-250-1000  
1000 ohms  
per volt

MILLI-  
AMPERES  
D.C.  
1-10-100-1000

CAPACITY  
.001 - 10 Mfd.  
Paper or  
electrolytic  
condensers

INDUCTANCE  
1 - 10,000 Henrys

.5-5,000,000 ohms D.C. Resistance

Send 6¢ in stamps for the new Bulletin No. 611-P containing the complete wiring diagram and operating instructions for this modern serviceman's instrument.

**SHALLCROSS MFG. COMPANY**  
Electrical Measuring Instruments  
and Accurate Resistors  
700 MAC DADD BOULEVARD  
COLLINGDALE, PA.

## FREE! NEW RADIO CATALOG

Packed with new-model radio VALUES at rockbottom wholesale prices. Money-back guarantee and 30-DAY FREE TRIAL IN YOUR HOME on every set! All types. Send for big, new FREE catalog \$9.45 Up TODAY. Prices.....

FORDSON RADIO, Inc.

Dept. 8-39, Oakman Bldg.

DETROIT, MICH.

**AGENTS WANTED!**  
**MOTION PICTURE SOUND**  
Most fascinating field awaits live Radio Service Men—quick, sure profits  
**ASK FOR FREE CATALOG**  
**S.O.S. CORPORATION**  
1600 Broadway New York, N. Y.  
Cable Address: "Sosound" New York

**SERVICEMEN!**  
THE MOST COMPLETE LINE OF CONDENSERS AND RESISTORS FOR EVERY RADIO USE  
Write for our new 30-page Catalog folder free of charge  
**AEROVOX**  
CORPORATION  
76 Washington Street Brooklyn, N. Y.

**A-C CURRENT-ANYWHERE!**  
WITH **Kato LIGHT PLANTS**  
Operates AC radios, amplifier refrigerators, and all other standard household appliances. Sizes 300 watts and up. Write for interesting descriptive literature.  
**KATO ENGINEERING CO.**  
Mankato, Minn., U.S.A.  
Mfgs. of AC Generators and Converters for operating AC Radios on 22 and 110 volts DC

# RTC's Big August SPECIALS

## YOUR DOLLAR— IS WORTH MORE When You Buy From Us

Is the dollar inflated? These days everybody is speaking of inflation but why worry about it, whether the dollar is inflated or not it is worth more when you buy from us. The prices shown on this page are so radically low that no one can possibly undersell them. Our consistent advertisements present to you each month, on this page, certain STAR (\*) items which are not listed in our regular catalog. These are all specials of which the small quantity on hand does not permit us to catalog them. **ONCE SOLD OUT NO MORE CAN BE HAD AT ANY PRICE, ORDER TODAY—NOW.** Order direct from this page and save money. 100% satisfaction guaranteed on every transaction.

We are a wholesale house and cannot accept orders for less than \$3.00. If C.O.D. shipment is desired, please remit 20% of the total amount of your order. Balance will go forward C.O.D.

If full cash accompanies your order deduct 2% discount. Send money order, certified check or U. S. stamps.

Be sure to include sufficient extra remittance if order is to be shipped via parcel-post; any excess will be refunded.



**FREE**

**RADIO and Short-Wave TREATISE**

108 Pages 1500 illus.

Completely revised and enlarged, this new 1934 edition contains 108 solid pages of useful radio information, diagrams, illustrations, radio kinks and real live radio merchandise. It contains more valuable radio information—more real live "meat"—than many text books on the subject. **PARTIAL LIST OF CONTENTS:** Fundamental Principles of Radio for the Beginner, Chapter 2—Fundamental Circuits and Uses of New Tubes—Revaning Six Volt Battery Sets for Two Volt Tubes—Public Address Systems—How to Build Short Wave Transmitters and Receivers—Up to Date Tube Chart and Socket Connections, etc., etc. **WRITE TODAY**—Enclose five cents (coin) for postage. Treatise sent by return mail. Print name and address clearly on request.

## BIG 8-TUBE SET BARGAIN

★ Complete with 11" Dynamic Speaker

Limited Supply

only **\$13.95**



*Not a Midget!— but a full-sized CONSOLE CHASSIS*

"THE GREATEST SET BUY IN AMERICA" is by all means a mild description of the value which we are offering here. This very same 8-tube receiver as recent as eight months ago, sold for more than \$25.00 yet now because of the advent of even later type tubes, you can purchase this receiver for only a small fraction of that price. The tubes employed in this set are still comparatively new; and not only that but all modern features such as, 2A5 push-pull output, tone control, phonograph attachment provisions, full dynamic speaker, etc., are incorporated.

The selectivity and sensitivity of this 8-tube receiver, due to its 4 tuned stages, are just as sharp as those of an 11-tube superheterodyne. The construction of the set is best described as "standard" for its circuit is none other than the "good old stand-by" T.R.F. type, modified and improved to use these later type tubes. It incorporates 3 stages of tuned R.F. amplification, using type 58 triode grid tubes, followed by a 56 detector. From there the signal is amplified by a type 56 first audio tube, and from there still further amplified by the powerful push-pull 2A5 power output tubes. By the time the signal comes out of these tubes, it is strong enough to operate 4 to 5 dynamic speakers very easily, and many times that number magnetic speakers. A type 80 full-wave rectifier is employed. All provisions for supplying field power to the 11" genuine Oxford dynamic speaker, is incorporated.

Tuning is extremely simple and very sharp, being comparable to the tuning of a superheterodyne receiver. A new type traveling "short light" is employed. The three controls on the front of the chassis consist of tuning knob, tone control knob and volume control respectively. The chassis itself is made of heavy steel, beautifully black enameled. All tuned circuits are thoroughly shielded including the tubes and condensers. This prevents feedback, whistling and howling. The use of 4 tuned circuits employing the new triode grid, screen grid tubes and high gain I.T.F. transformers, together with careful wiring

and by-passing, results in extremely high sensitivity. Many of our satisfied customers inform us that a good variety of distant stations come in regularly like locals. And why shouldn't they, for 4 tuned stages is more than what even more recent sets are employing and everyone knows that the more tuned stages you have the greater is the sensitivity and particularly the selectivity of a receiver. Tone quality too, is extremely fine and can be controlled to suit the individual, from very high treble down to deep bass.

Why build a set when a complete receiver, fully wired and ready to use and complete with speaker and all modern features, can be bought at such a phenomenally low price. Here, also, is an opportunity for wide-awake servicemen to "clean up." There are little more than 150 of these excellent chassis available, hence "first come, first served." Judging by the rapidity with which our "Peerless" receivers sold a few months back, when we had a sale on them, the supply of these considerably superior receivers will not hold out very long. The moral is, "don't delay, order today." Overall size of chassis, 15½" x 11" 8½". Shipping weight, 40 lbs.

List Price \$35.00  
No. 2000—8-Tube T.R.F. Receiver including Dynamic Speaker But Less Tubes **\$13.95**  
YOUR PRICE .....



## WORLD-WIDE RECEPTION WITH THE FAMOUS "TWINPLEX" Short-Wave Receiver

**2-Sets in-1**

**Economical 2-Volt Operation Complete with Headphone**

**ONLY \$4.94**

**S**HORT waves are the talk of the hour. The whole country, nay, the whole world, has gone crazy to receive foreign stations, as far as 12,500 miles distant. Usually, such reception is had only with expensive multi-tube sets.

Only recently, the invention of the "19" tube has made it possible to perform the function of two tubes in a single tube. Then came the invention of the TWINPLEX, a radio circuit of unheard-of sensitivity, using the "19" tube; it is now possible with a single tube of this type to receive short wave stations from all over the world, loudly and clearly—REGULARLY, night after night, day after day, always in the same place on the dial.

Every radio man knows that in a short-wave set it is highly important to have the wiring as short as possible. By inventing a radically new design, that is, by mounting tubes and coils, in fact, everything, on the front panel, it has become possible to shorten all connecting wires, with the result that an UNHEARD OF SIGNAL SENSITIVITY has now been achieved for the first time, in a single-tube set.

But the TWINPLEX is ACTUALLY A TWO-TUBE SET; yes, we repeat, A FULL-FLEDGED TWO-TUBE SET AT THE PRICE OF A ONE-TUBE SET. JUST IMAGINE, TWO TUBES IN ONE GLASS ENVELOPE. That is the story of the new "19" tube. It is a 2-volt tube, which has a DOUBLE SET OF ELEMENTS.

This set has been so designed that it will receive ordinary broadcast stations too—stations which come in with great volume, particularly local stations. These come in

so loud that if you have a loudspeaker, this little one-tube set will ACTUALLY GIVE YOU LOUDSPEAKER RECEPTION.

With this set, we furnish regularly, two coils, one a short-wave plug-in coil, which receives all the popular stations in the 33 to 65 meter band, and a broadcast coil which receives nearly all broadcast stations.

A simplified instruction sheet with detailed instructions and pictorial diagrams shows you how to build the set in a few hours' time, and once you have completed the set, FROM THEN ON, YOU DON'T SLEEP ANY MORE.

The "19" TWINPLEX is available ONLY in kit form and comprises all parts to properly build the receiver in from 1 to 2 hours. ANYONE CAN DO IT! Shipping weight 5 pounds.

No. SW-308 Famous Twinplex Short-Wave Receiver Kit with all parts INCLUDING SINGLE HEADPHONE AND BAND BUT NO TUBE **\$4.94**  
YOUR PRICE .....

No. SW-309 Complete Accessories For TWINPLEX Receiver, comprising 1—Type 19 Tube, 2—No. 6 Dry Cells, 2—45 volt "B" Batteries. Shipping weight 20 pounds. **\$3.55**  
YOUR PRICE .....

Additional Plug-in Coils for the 20, 80 and 160 meter bands—45c each

**RADIO TRADING COMPANY, 97 Hudson Street, New York City**

# Penny Wise - BUT Dollar PROFIT

## To Every Radio Manufacturer Jobber and Mail Order House

The June issue of RADIO-CRAFT concluded the first five-year period since the magazine's inception.

With no little effort and persistence, the publishers have succeeded in bringing out sixty consecutive issues. It is a testimonial to the merits of any magazine that, in its infancy, it was able to pass successfully through the crucial, depression days. And, NOW, RADIO-CRAFT has become the second largest radio monthly magazine in the country. Such success is due in great measure to its splendid, enthusiastic organization.

In this half-decade, RADIO-CRAFT has attained a circulation far in excess of 50,000 monthly readers, comprising manufacturers, jobbers, radio dealers, service men, radio engineers, experimenters and professional set builders. Present indications point to a fair percentage of increase during the next few months. What does the future hold? Well, we're confident of continued success.

We recall the early days when only a handful of advertisers were represented in the pages of RADIO-CRAFT. Today, we find an average of 50 or more advertisers using space regularly month after month. Many of them have never missed an issue since July, 1929.

The growth of RADIO-CRAFT in circulation, in prestige, in editorial interest, in value as an advertising medium, is conclusively proved by the results obtained by one of many advertisers. The letter reproduced is JUST ONE of any number of unsolicited letters received from time to time. It points out clearly the profits derived from advertising expenditures in RADIO-CRAFT — it shows reader response to advertising in RADIO-CRAFT — and it proves leadership in the radio field.

Advertisers and agencies are alert in taking advantage of new, prosperous markets. What greater prospects in a constantly buying field can be found? Where can a more active radio market be established? We know by confidential reports from other advertising accounts that results have ALWAYS been good. Its many invested wisely to bring dollar profits.

THE PUBLISHERS.

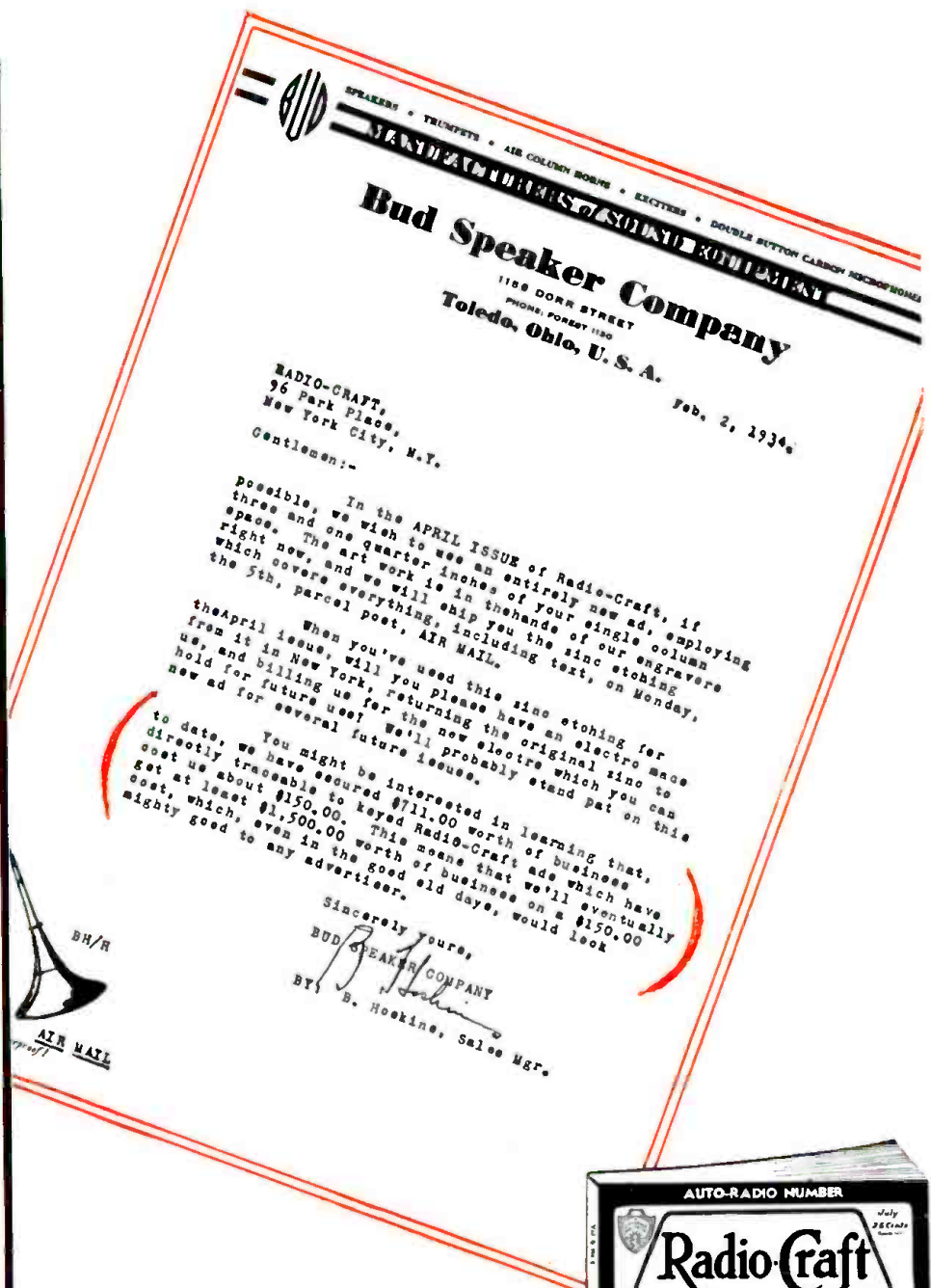

## RADIO-CRAFT

Published by Continental Publications, Inc.

99 HUDSON STREET

New York, N. Y.



# Learn at Home to Make More Money



**Here's Proof**

**"Made \$6000 in 2 Years"**

"Soon after the depression started, I found myself without a job, but I was well protected with N.R.I. training. I swung right to full time Radio Servicing and I have made over \$5,000 in a little over two years."  
—WM. SPARTIVENT, Sparty Radio Service, 93 Broadway, Newark, N. J.



**"Made \$17 in One Night"**

"Who says there's a depression? I have made more money in Radio than ever before. I am busy day and night. Last night I made \$17. Last week \$45. I had a tough struggle at first but you fellows helped me back in the race and kept me going."  
—WILLIAM J. MAKI, Creighton Mine, Ont., Canada.



**"\$500 a Year in Spare Time"**

"Although doing spare time Radio work only, I have averaged about \$500 a year extra in addition to my regular income. Full time Radio work would not me many things that amount."  
—EDW. H. FAWCETT, Slough Road, Ladner, B. C., Canada.



**"Good Position, Good Pay"**

"I am Chief Operator at Radio Station WSAK. This is a good position with good pay. I have advanced in Radio right along. I recommend N.R.I. to anyone who wants to be Radio."  
—JOHN HADJUK, JR., 3 Broxey Ave., Southern Hills, Dayton, Ohio.



**I'll train You Quickly for Radio's GOOD spare time and full time Jobs . . .**

**Mail Coupon for FREE Information**

Why slave your life away in a no-future job? Why skimp, why scrape, trying to pay your bills? I'll train you quickly for the five-wire field—the field with a future—**RADIO**. \$40, \$60, \$75 a week—that's what many Radio Experts make. \$5, \$10, \$15 a week extra money—that's what many of my students make in their spare time shortly after enrolling. My free book tells you about Radio's spare time and full time opportunities—about my tested training—about my students and graduates—what they are doing and making. Get this book. Be a Radio Expert. The Radio field is big enough to absorb many more properly trained men.

**Many Radio Experts Make \$40, \$60, \$75 a Week**

Spare time and full time Radio Servicing, Operating Broadcast, Aircraft Radio, Commercial Land, Ship and Television stations, a Radio service business of your own. I'll train you for these and other good jobs in the manufacture, sale and service of Radio and Television apparatus. My FREE book tells you about the many money-making opportunities in Radio.

**Save—Learn at home in your spare time**

You don't have to leave home and spend \$500 to \$1,000 to study Radio. I'll train you quickly and inexpensively right in your own home and in your spare time for a good Radio job. You don't need a high school or college education. Many of my successful graduates didn't even finish grade school. My amazingly practical 50-50 method of training—half with lessons, half with Radio equipment—gives you broad practical experience—makes learning at home easy, fascinating, practical and rapid.

**Many make \$5, \$10, \$15 a week extra in spare time almost at once**

My book shows how my special training, instruction material, plans, ideas, and my nineteen years' experience training men for Radio careers have helped many students make \$200 to \$1,000 a year quickly in their spare time. My Course is famous as "the one that pays for itself."

**Your money back if not satisfied**

I'm so sure you will be satisfied with my training that I agree in writing to refund every penny of your money if you are not entirely satisfied with my Lesson and Instruction Service when you finish.

**Find out what Radio offers you**

Act today. Mail the coupon. My 64-page book will be sent free to any ambitious fellow over 15 years of age. It tells about Radio's opportunities—explains the eighteen star features of my Course—shows letters of what others are doing and making. There is no obligation. Mail the coupon in an envelope, or paste it on a 1c post card.

**J. E. SMITH, President,  
National Radio Institute  
Department 4-HX, Washington, D. C.**

**FREE: Radio Servicing Tips**

Let me PROVE that my Course is clear, easy to understand and fascinating to study. Send the coupon for a free lesson, "Trouble Shooting in D.C., A.C. and Battery Sets." This interesting lesson gives 132 ways to correct common Radio troubles. I am willing to send this book to prove that you too can master Radio just as thousands of other fellows have done. Many of them, without even a grammar school education, and no Radio or technical experience, have become Radio experts and now earn two or three times their former pay. Mail the coupon now.



Broadcasting Stations employ managers, engineers, operators, installation and maintenance men for jobs paying up to \$5,000 a year.



Set servicing has paid many N. R. I. men \$200 to \$1,000 a year for their spare time. Full time men make as much as \$40, \$60, \$75 a week.



Television, the coming field of great opportunities, is covered in my Course.

**Some Other Jobs N.R.I. Trains Men For**

- Broadcast Engineer.
- Operator in Broadcast Station.
- Aircraft Radio Operator.
- Operator of Airway Beacons.
- Government Radio Operator.
- Ship Operator.
- Serviceman on Loud Speaker Systems.
- Installation Engineer on Loud Speaker Systems.
- Sales Manager for Retail Stores.
- Service Manager for Retail Stores.
- Auto Radio Installation and Serviceman.
- Television Broadcast Operator.
- Television Engineer.
- Set Servicing Expert.

**MAIL THIS for FREE 64 page book**

**ACK TODAY**  
 I want to take advantage of your Special  
 and Battery Sets" and "Rich Rewards in Radio." I understand  
 this does not obligate me. (Please print plainly.)  
 NAME \_\_\_\_\_ AGE \_\_\_\_\_  
 ADDRESS \_\_\_\_\_  
 CITY \_\_\_\_\_ STATE \_\_\_\_\_ M